

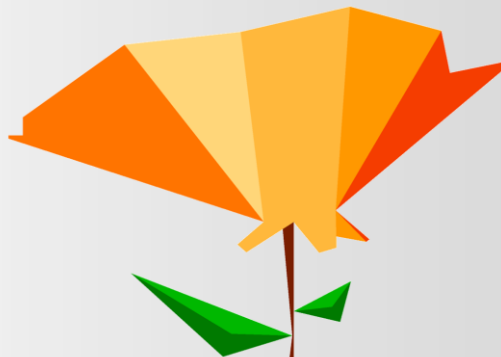

PREFEITURA
NITERÓI
FEITA POR VOCÊ



BANCO DE DESENVOLVIMENTO
DA AMÉRICA LATINA



PRO-SUSTENTÁVEL

PARQUE ORLA PIRATININGA

Proposta inicial de Projeto Básico

TRECHOS 3, 4, 5, 6 e 7

17/06/2019

PARQUE ORLA PIRATININGA



PARQUE ORLA PIRATININGA: Trechos





URBANISMO

PRINCIPAIS ACESSOS AO PARQUE



INFRAESTRUTURA CICLOVIÁRIA

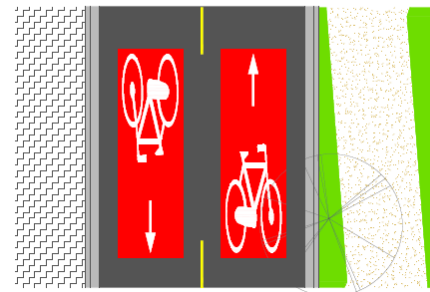
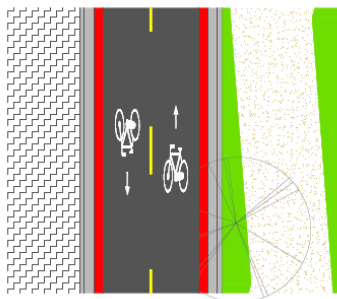
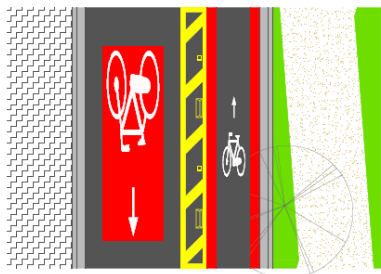
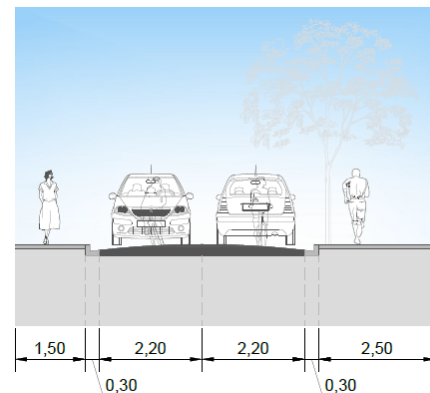
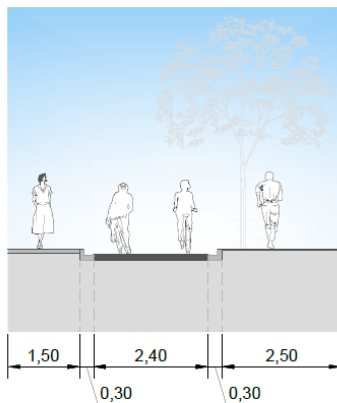
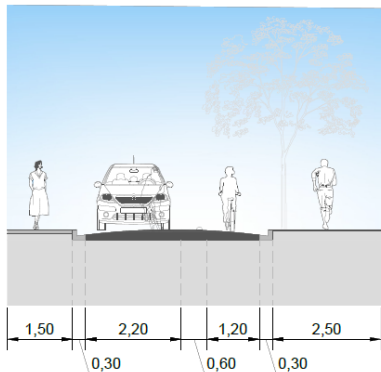

INFRAESTRUTURA CICLOVIÁRIA

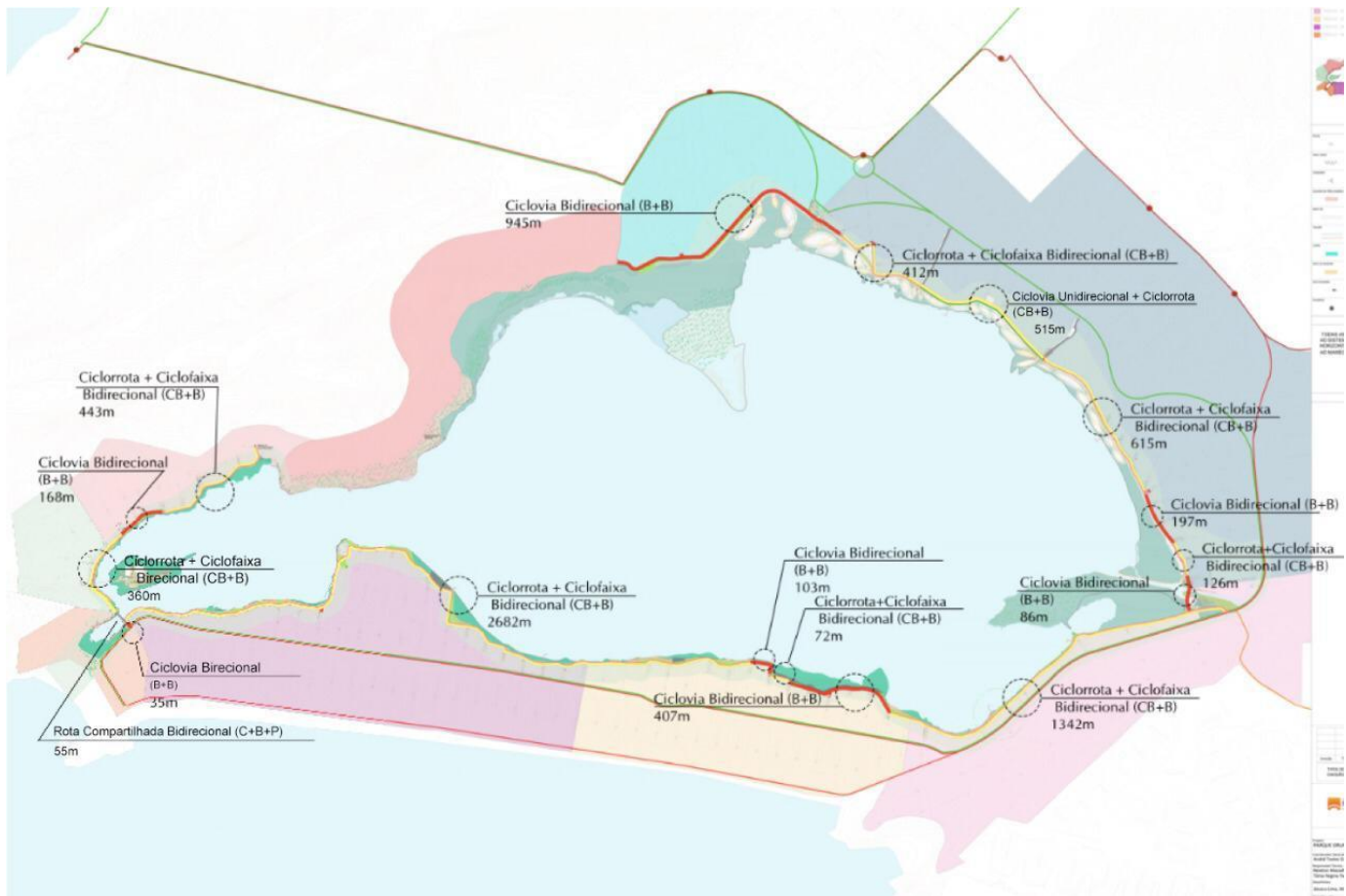

ÁREAS DE LAZER

-  PIER DE CONTEMPLAÇÃO
-  PIER DE PESCA
-  ÁREA INFANTIL
-  ACADEMIA
-  QUADRA POLIESPORTIVA
-  CHURRASQUEIRA

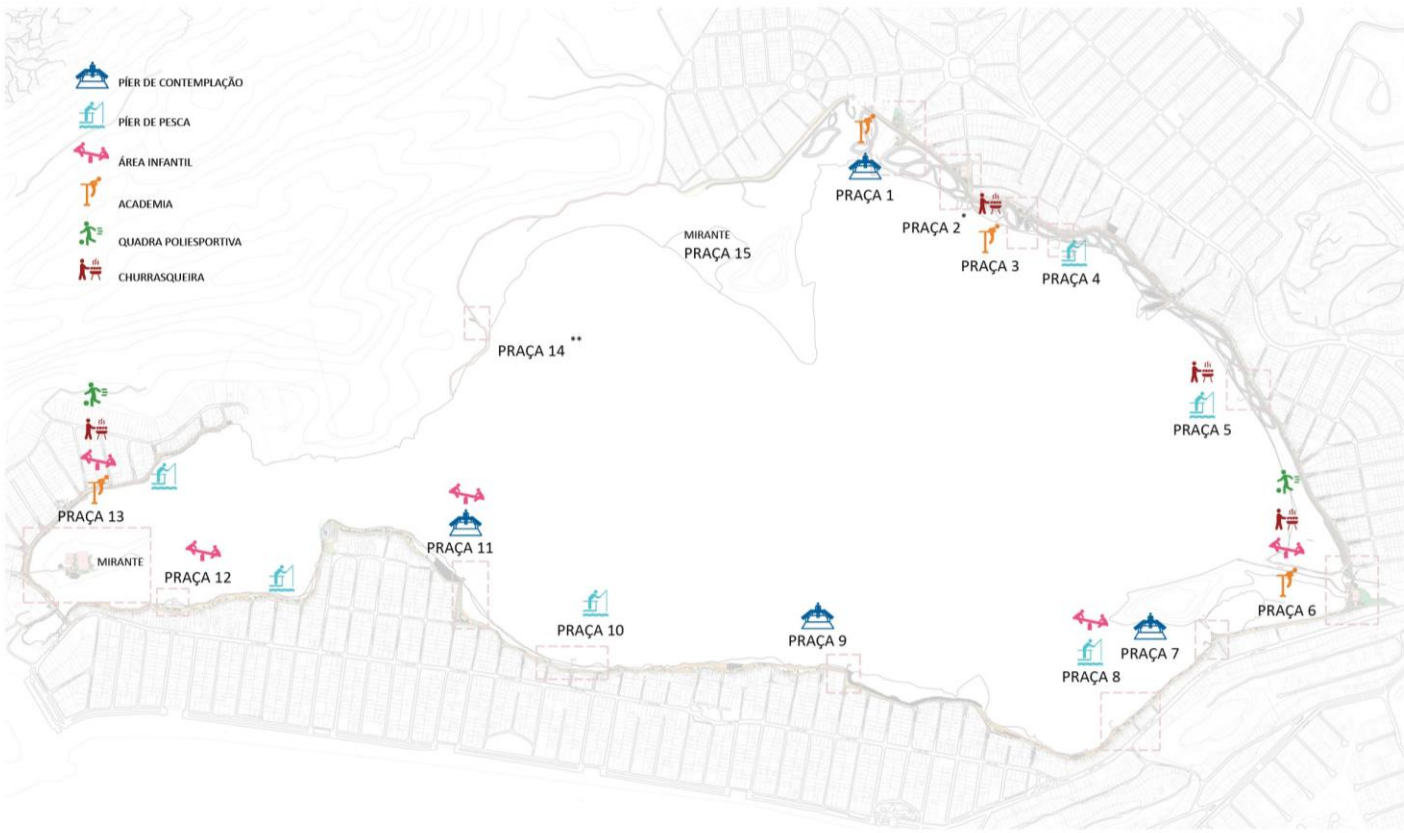

PARQUE ORLA PIRATININGA: Trecho 3

► RUA DR. WILSON VIEIRA A RUA PROFESSOR MANUEL JOSÉ FERREIRA



PARQUE ORLA PIRATININGA: Trecho 3

▶ TIPOLOGIA CICLOVIÁRIA

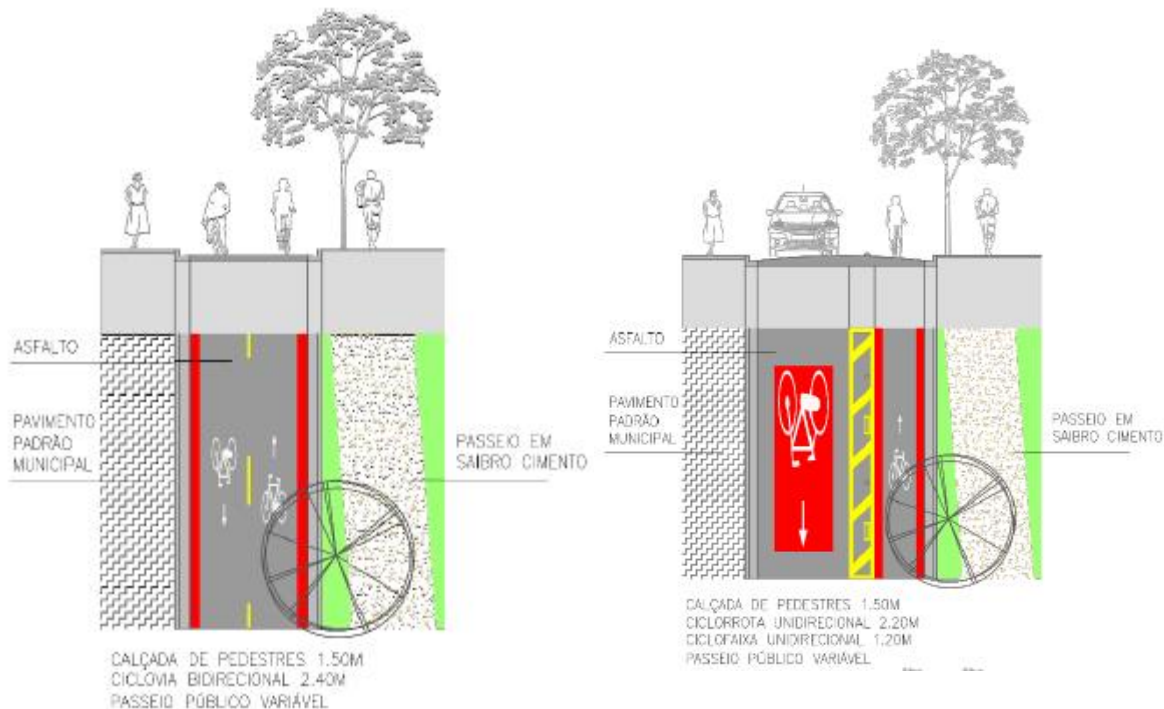

PARQUE ORLA PIRATININGA: Trecho 3

▶ RUA DR. WILSON VIEIRA A RUA PROFESSOR MANUEL JOSÉ FERREIRA



PARQUE ORLA PIRATININGA: Trecho 3

▶ RUA DR. WILSON VIEIRA A RUA PROFESSOR MANUEL JOSÉ FERREIRA

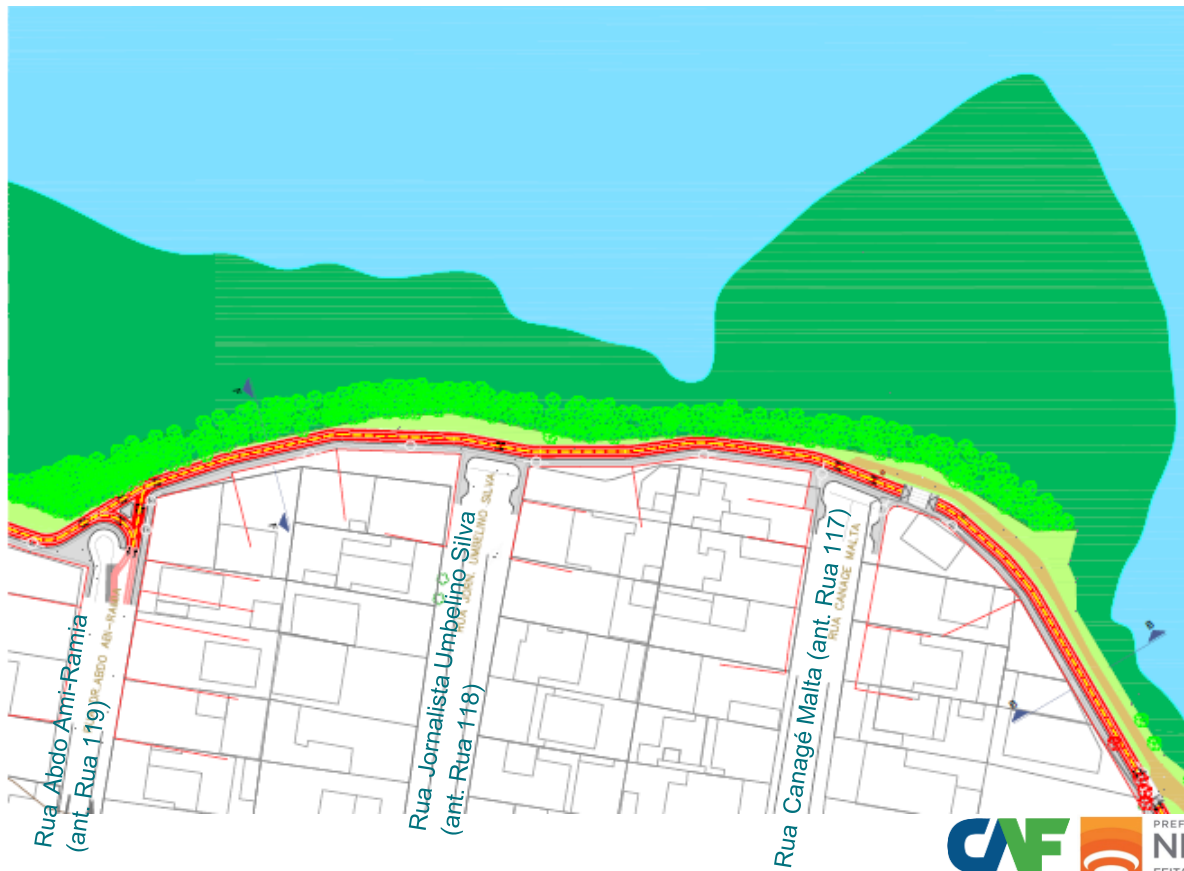

PARQUE ORLA PIRATININGA: Trecho 3

▶ RUA DR. WILSON VIEIRA A RUA PROFESSOR MANUEL JOSÉ FERREIRA

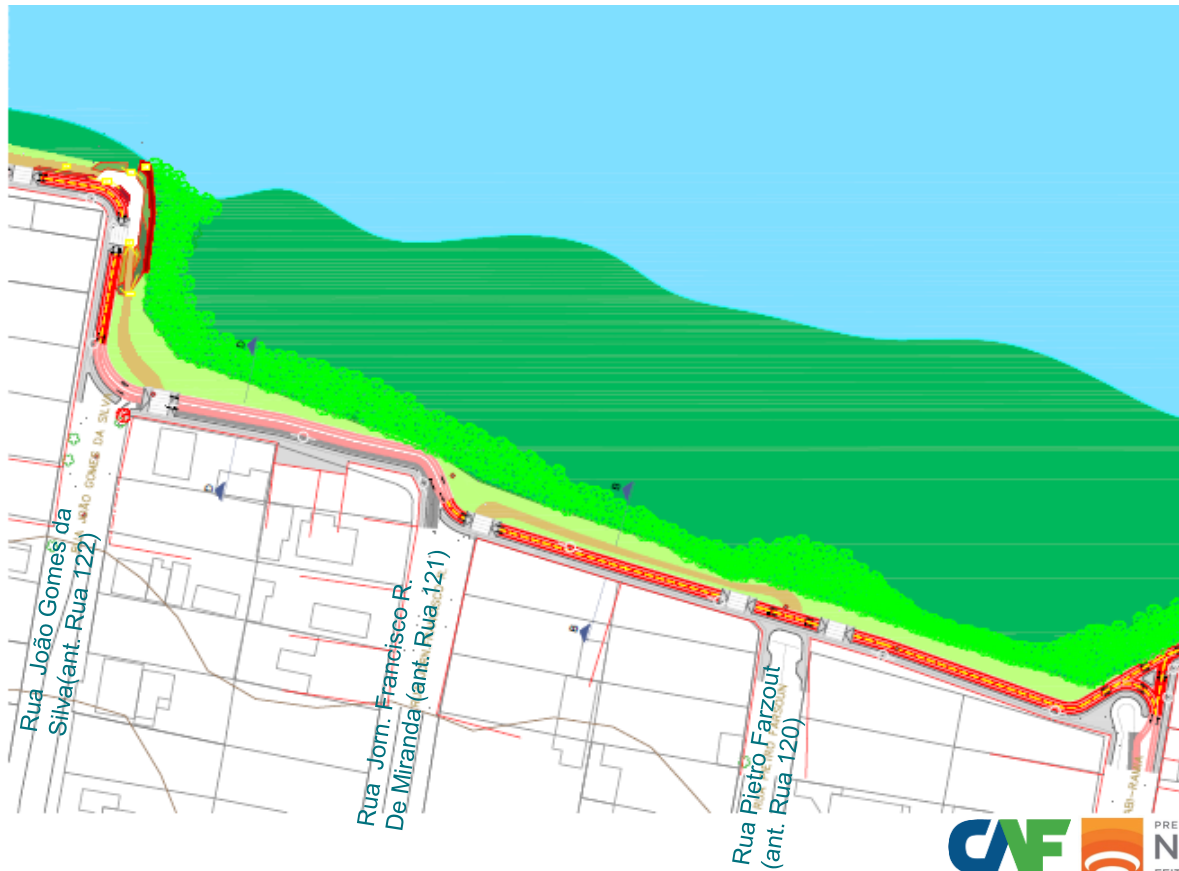

PARQUE ORLA PIRATININGA: Trecho 8

▶ ÁREA DE ESTAR

- ▶ 2 bancos
- ▶ Pier de contemplação
- ▶ Paraciclos
- ▶ Piso: saibro cimento

Localização

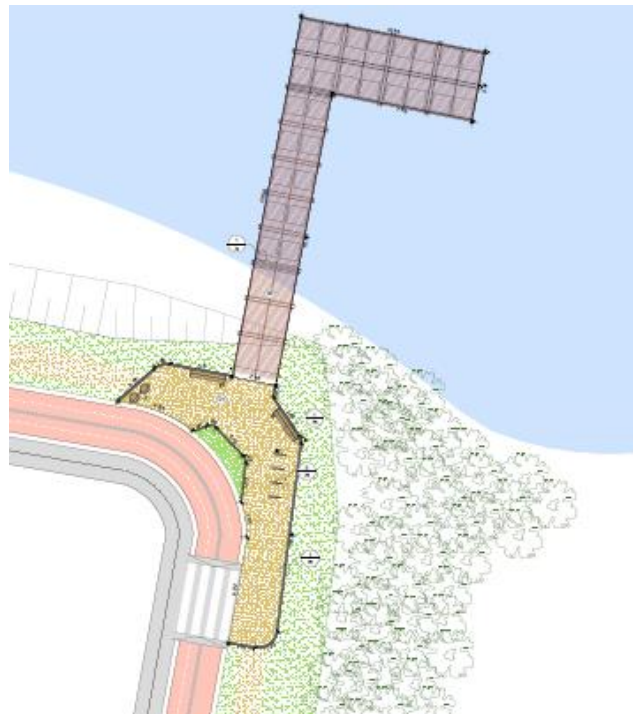
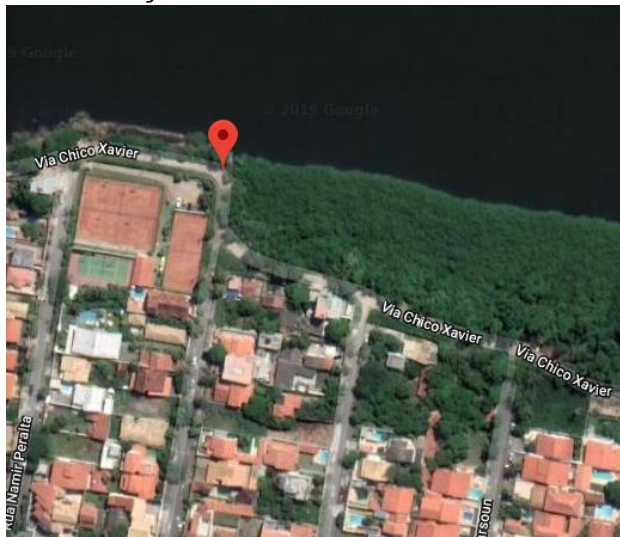

PARQUE ORLA PIRATININGA: Trecho 3

▶ RUA DR. WILSON VIEIRA A RUA PROFESSOR MANUEL JOSÉ FERREIRA

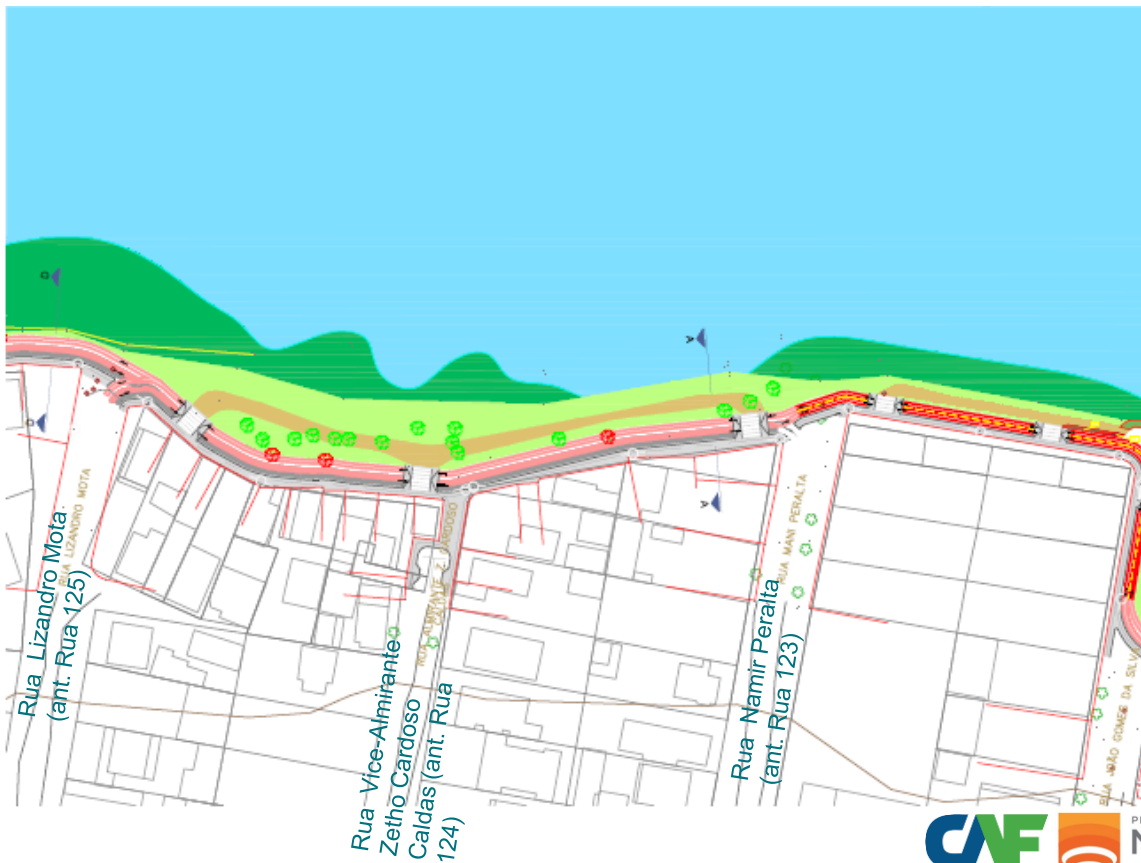

PARQUE ORLA PIRATININGA: Trecho 3

▶ RUA DR. WILSON VIEIRA A RUA PROFESSOR MANUEL JOSÉ FERREIRA

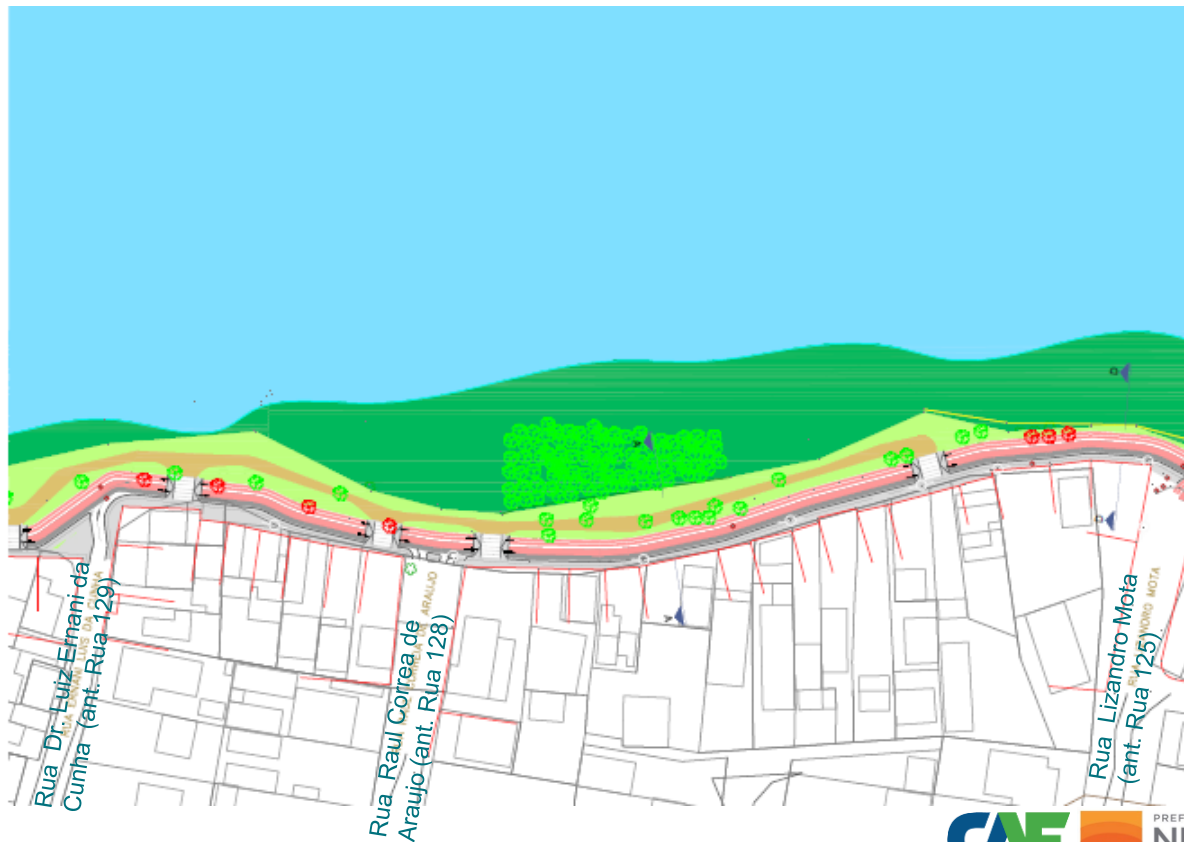

PARQUE ORLA PIRATININGA: Trecho 3

▶ RUA DR. WILSON VIEIRA A RUA PROFESSOR MANUEL JOSÉ FERREIRA

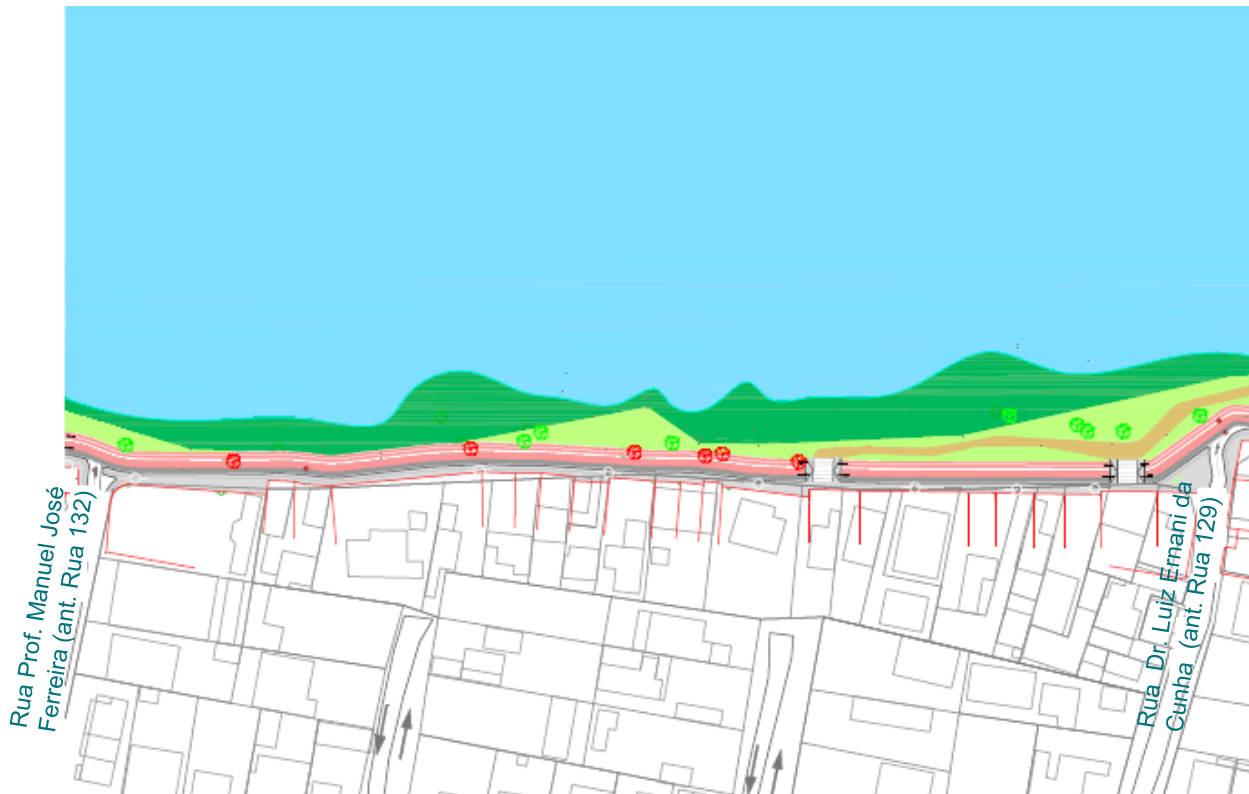

PARQUE ORLA PIRATININGA: Trecho 3

▶ RUA DR. WILSON VIEIRA A RUA PROFESSOR MANUEL JOSÉ FERREIRA

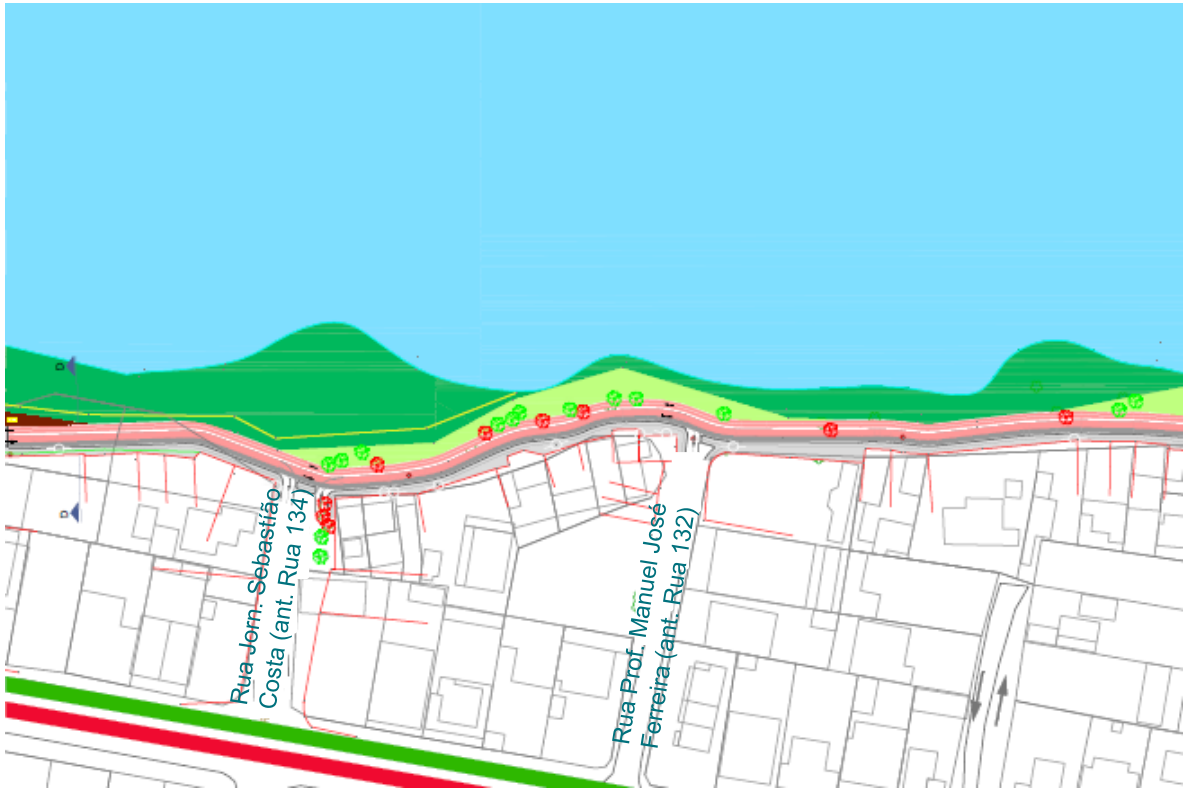

PARQUE ORLA PIRATININGA: Trecho 4

- ▶ RUA PROFESSOR MANUEL JOSÉ FERREIRA A RUA BATISTA LACERDA BOTELHO



PARQUE ORLA PIRATININGA: Trecho 4

▶ TIPOLOGIA CICLOVIÁRIA

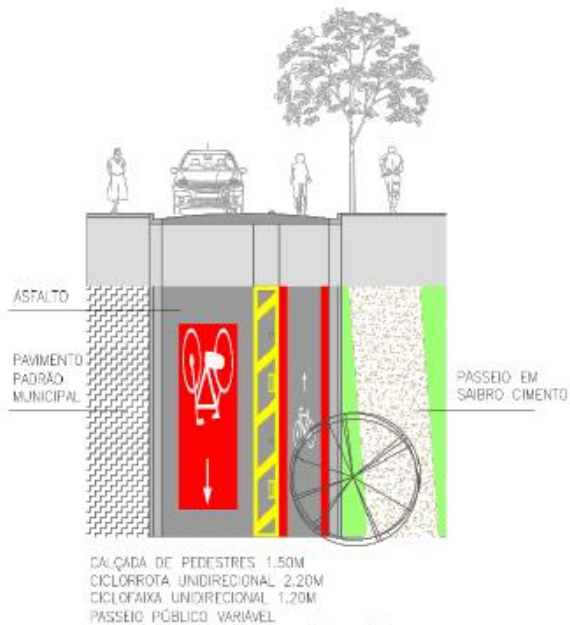

PARQUE ORLA PIRATININGA: Trecho 4

▶ RUA PROFESSOR MANUEL JOSÉ FERREIRA A RUA BATISTA LACERDA BOTELHO

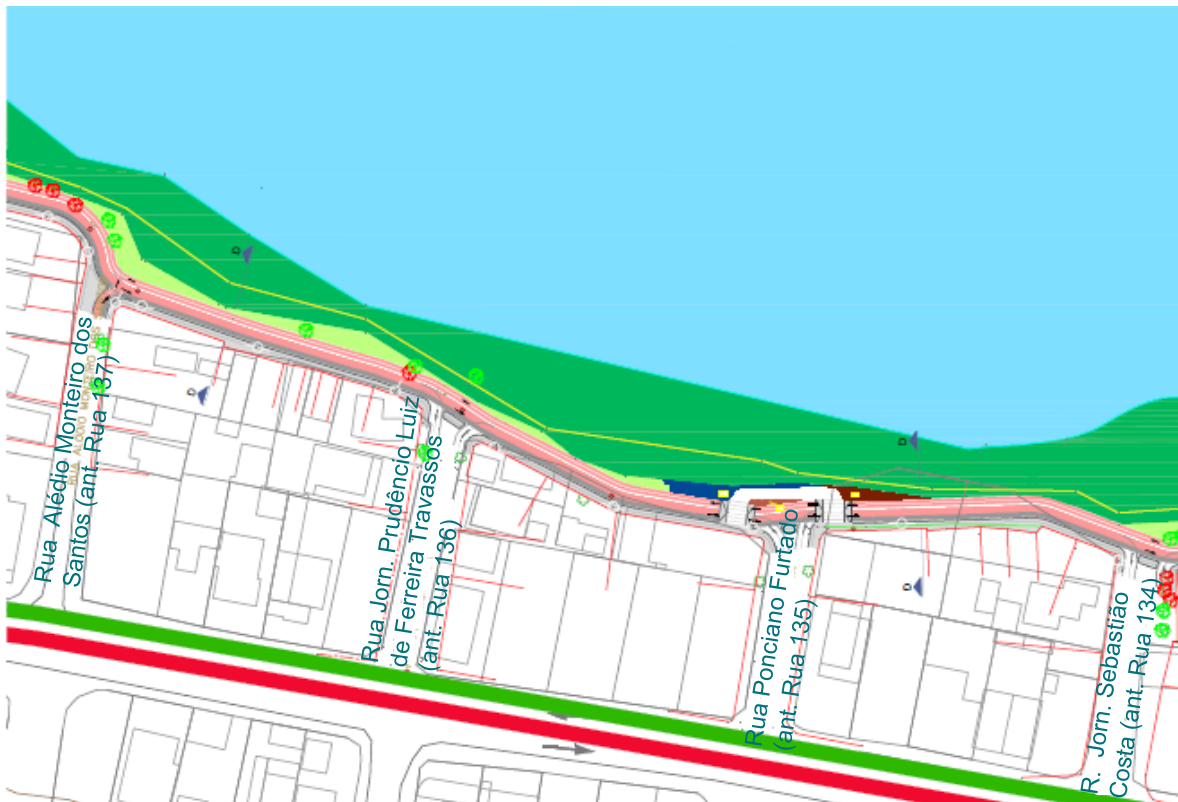

PARQUE ORLA PIRATININGA: Trecho 4

▶ RUA PROFESSOR MANUEL JOSÉ FERREIRA A RUA BATISTA LACERDA BOTELHO

- ▶ 2 bancos
- ▶ Píer de pesca
- ▶ Paraciclos
- ▶ Piso: saibro cimento

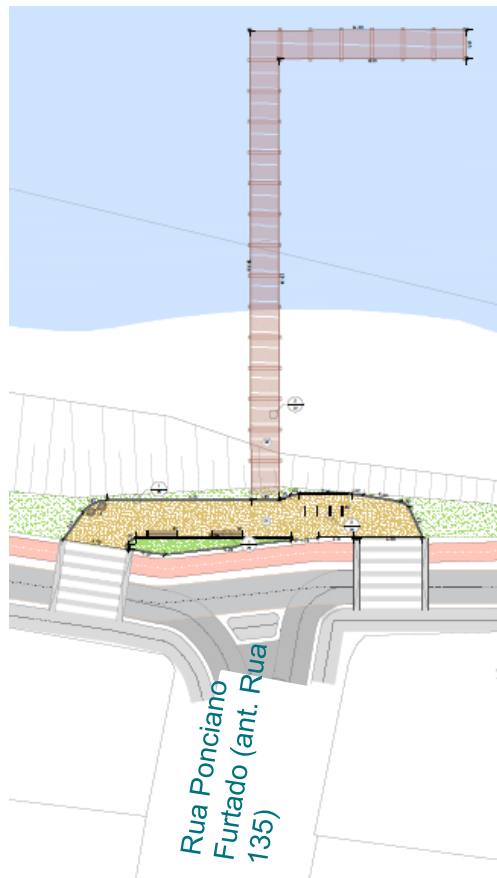

Localização



PARQUE ORLA PIRATININGA: Trecho 4

▶ RUA PROFESSOR MANUEL JOSÉ FERREIRA A RUA BATISTA LACERDA BOTELHO

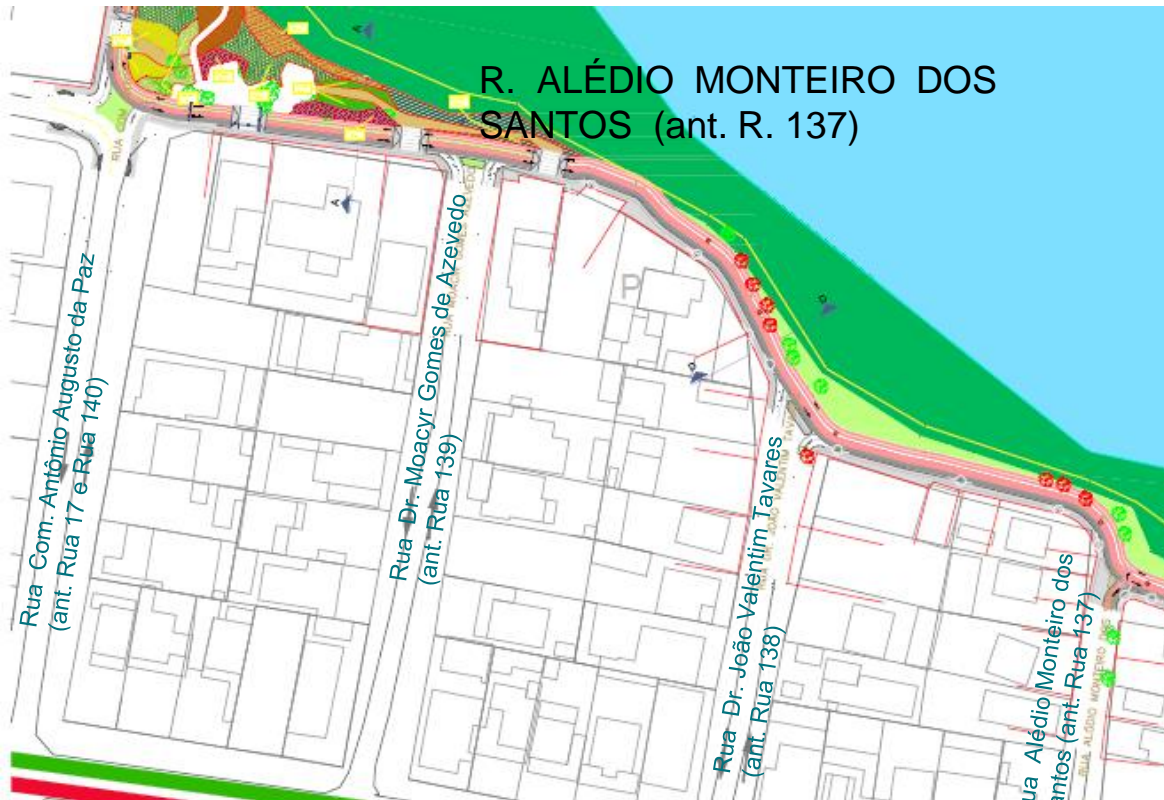

PARQUE ORLA PIRATININGA: Trecho 4

▶ RUA PROFESSOR MANUEL JOSÉ FERREIRA A RUA BATISTA LACERDA BOTELHO

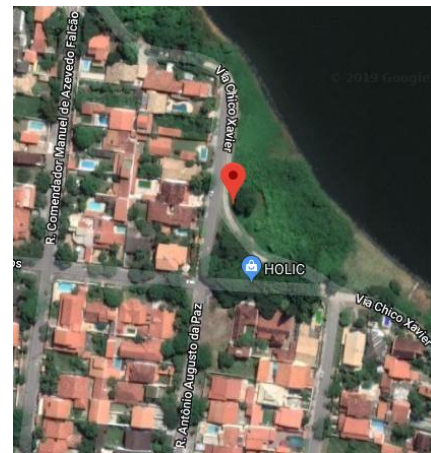

Localização

- ▶ Brinquedos infantis
- ▶ 1 Mesa
- ▶ 7 Bancos
- ▶ Paraciclos
- ▶ Piso: saibro cimento

PARQUE ORLA PIRATININGA: Trecho 4

▶ RUA PROFESSOR MANUEL JOSÉ FERREIRA A RUA BATISTA LACERDA BOTELHO



- ▶ Píer de contemplação
- ▶ 2 Bancos
- ▶ Paraciclos
- ▶ Piso: saibro cimento

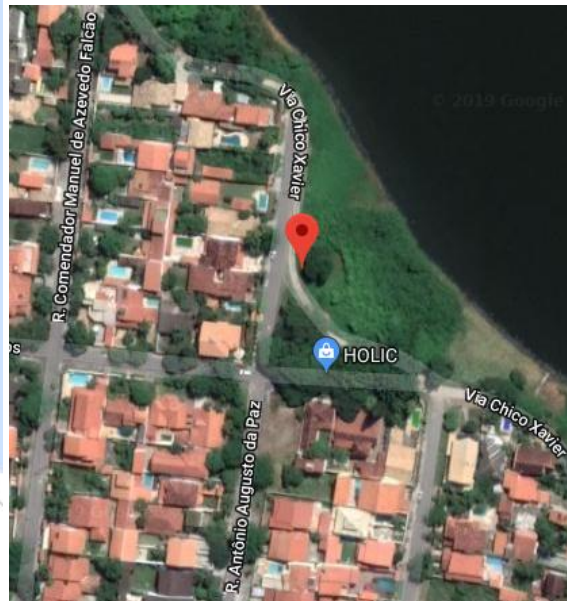

Localização

PARQUE ORLA PIRATININGA: Trecho 4

- ▶ RUA PROFESSOR MANUEL JOSÉ FERREIRA A RUA BATISTA LACERDA BOTELHO



PARQUE ORLA PIRATININGA: Trecho 4

- ▶ RUA PROFESSOR MANUEL JOSÉ FERREIRA A RUA BATISTA LACERDA BOTELHO

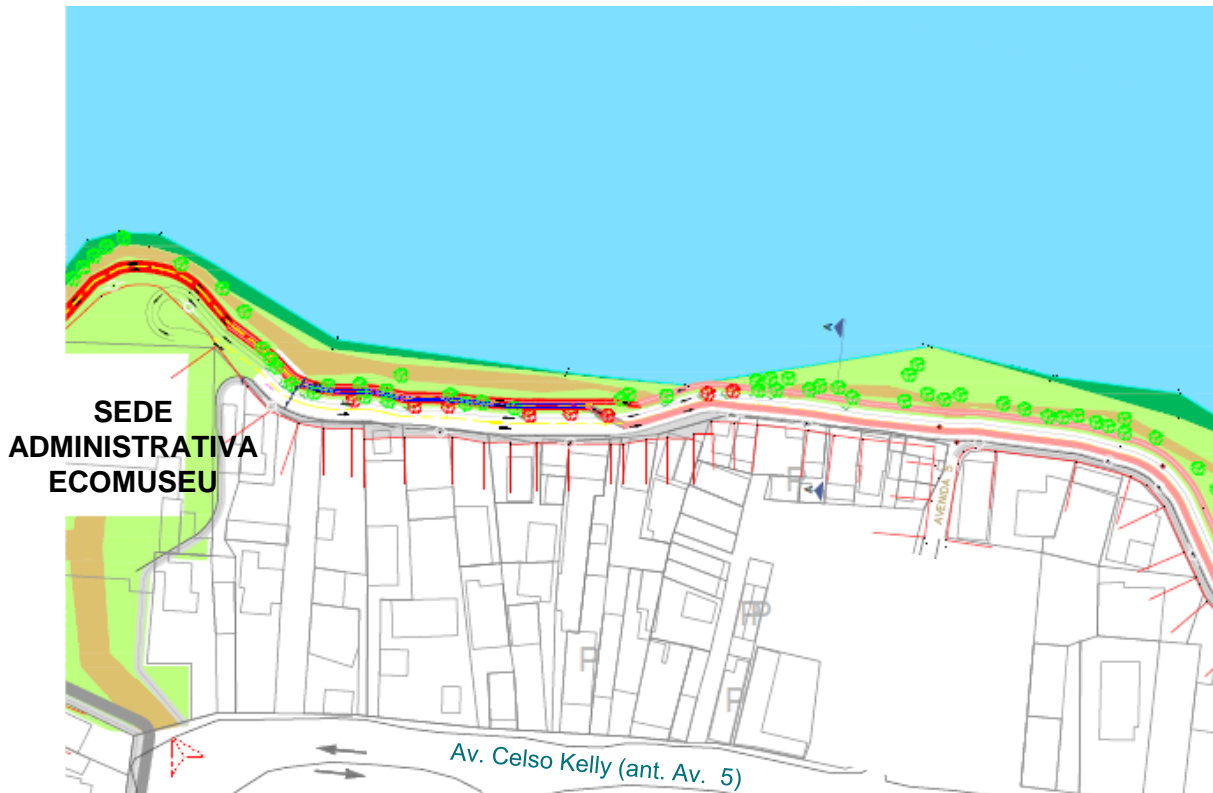

PARQUE ORLA PIRATININGA: Trecho 4

- ▶ RUA PROFESSOR MANUEL JOSÉ FERREIRA A RUA BATISTA LACERDA BOTELHO



▶ SEDE ADMINISTRATIVA / ECOMUSEU

▶ PROGRAMA DE NECESSIDADES

- ▶ Recepção
- ▶ Sala multiuso
- ▶ Guarderia
- ▶ Bicicletário
- ▶ Restaurante
- ▶ Sala administrativa e Sala de reuniões
- ▶ Deck de contemplação

PARQUE ORLA PIRATININGA: Trecho 4

▶ SEDE ADMINISTRATIVA / ECOMUSEU

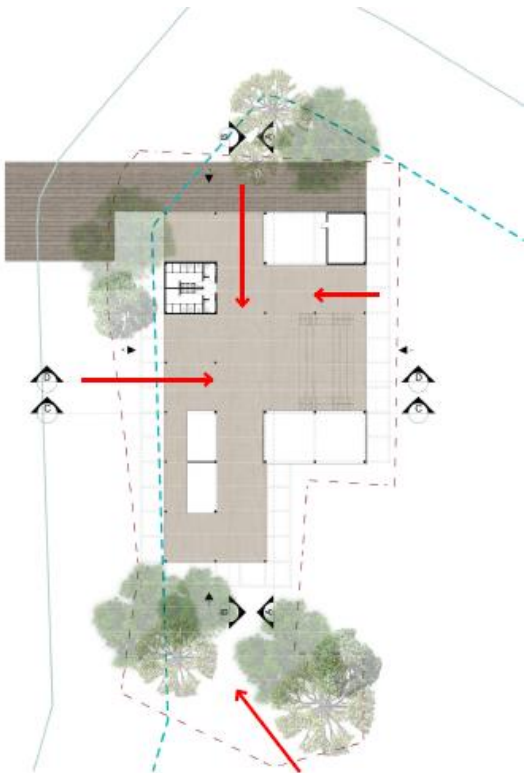

Localização

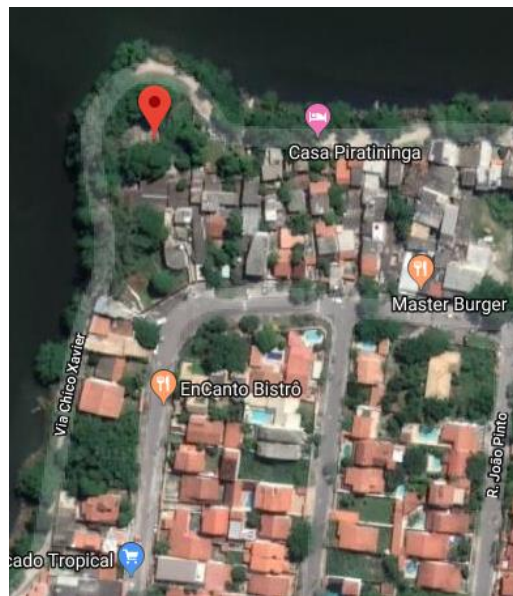

PARQUE ORLA PIRATININGA: Trecho 4

▶ SEDE ADMINISTRATIVA / ECOMUSEU



PARQUE ORLA PIRATININGA: Trecho 4

▶ SEDE ADMINISTRATIVA / ECOMUSEU



PARQUE ORLA PIRATININGA: Trecho 4

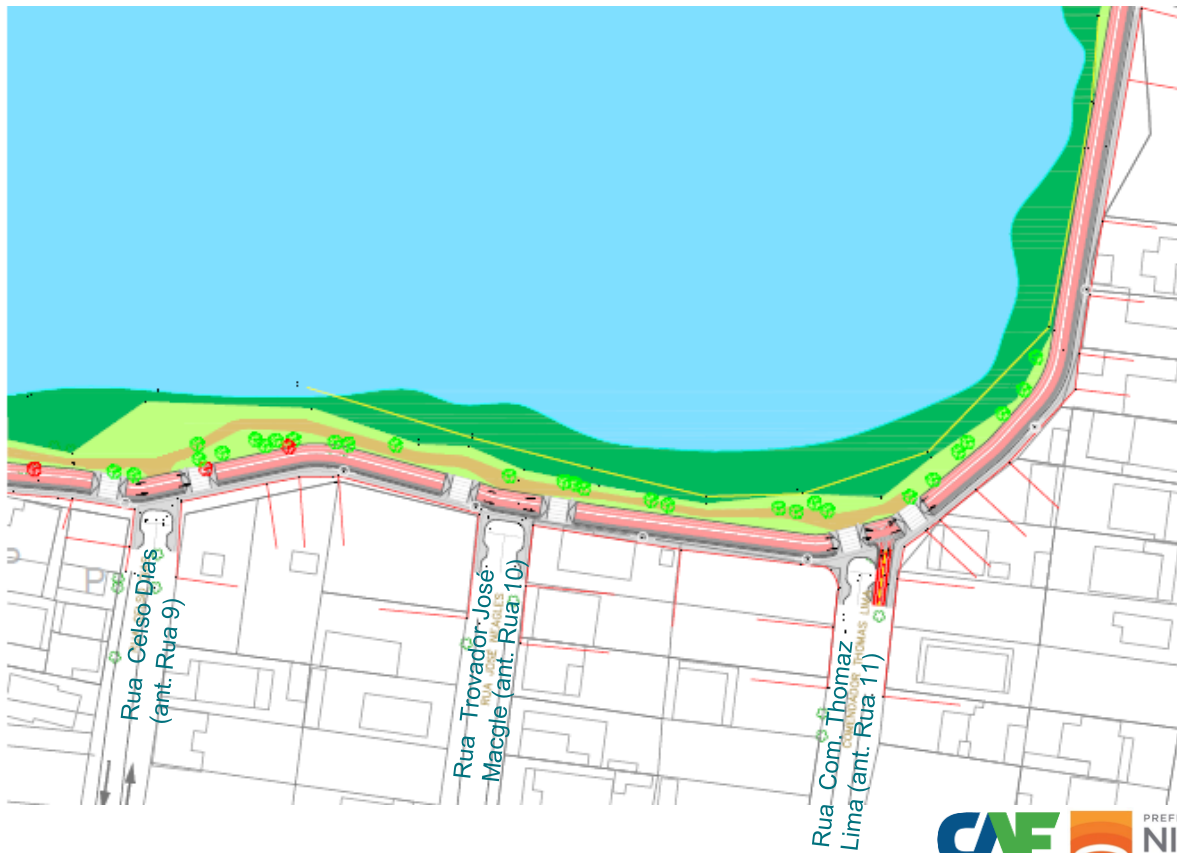

PARQUE ORLA PIRATININGA: Trecho 4

▶ PÍER DE PESCA – FINAL DA RUA CELSO DIAS GOMES

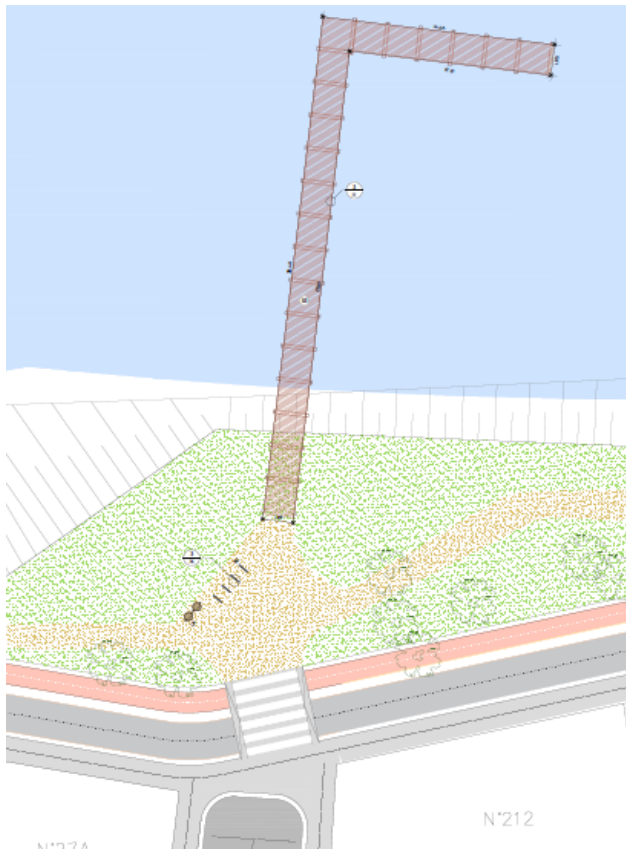

Localização



PARQUE ORLA PIRATININGA: Trecho 4

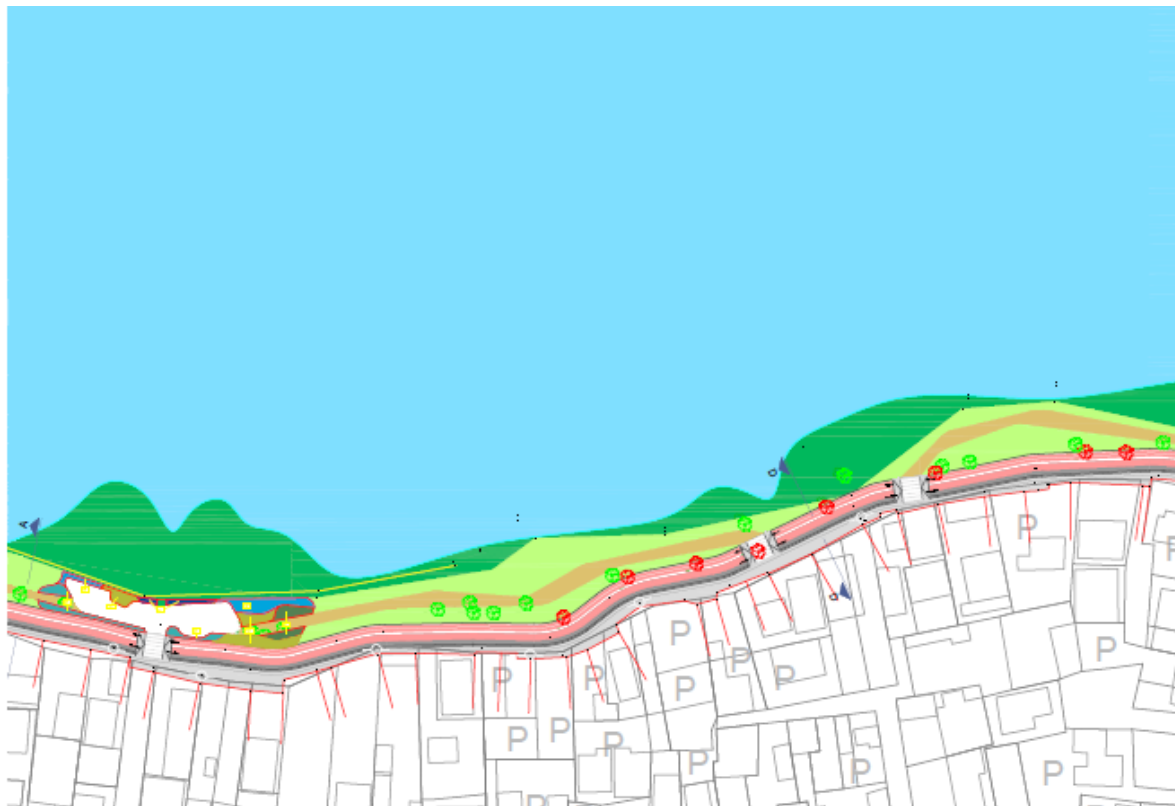

PARQUE ORLA PIRATININGA: Trecho 4

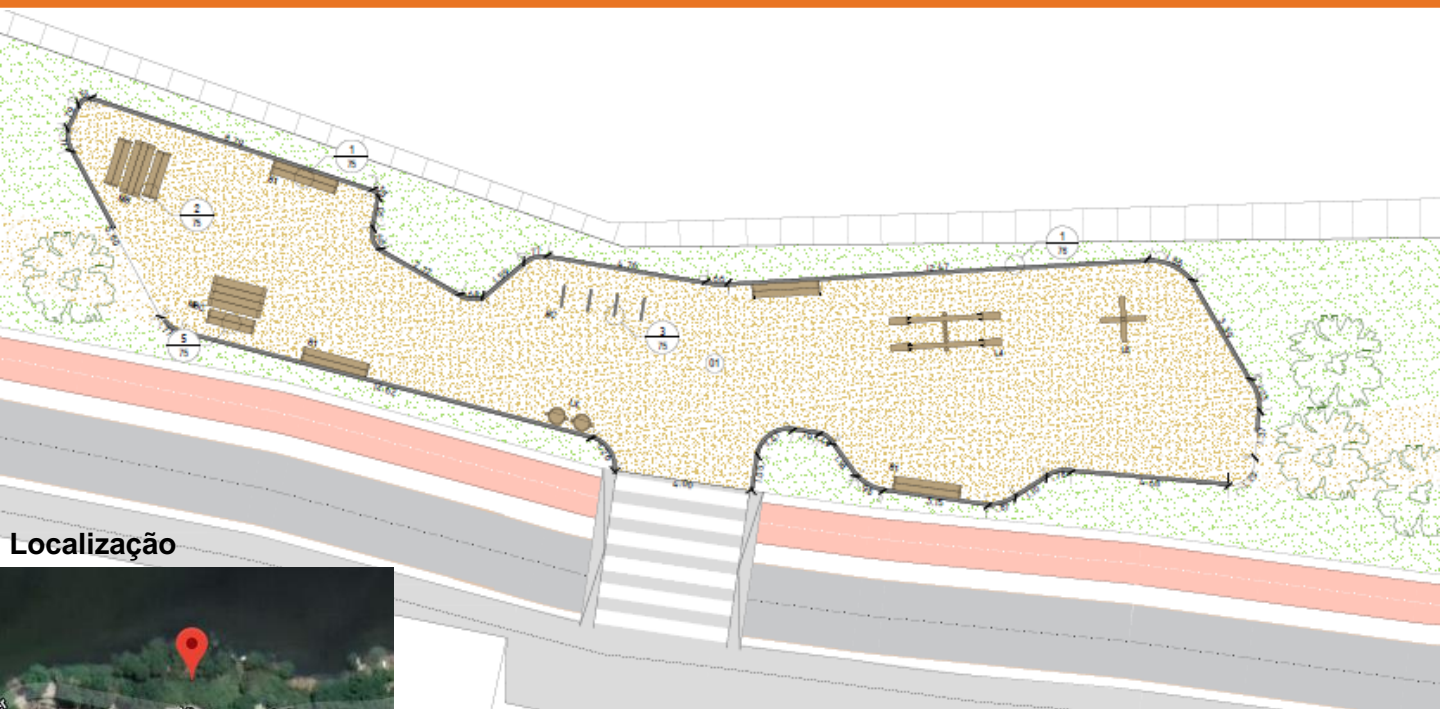

Localização



- ▶ Brinquedos infantis
- ▶ 2 mesas
- ▶ 4 Bancos
- ▶ Paraciclos
- ▶ Piso: saibro cimento

PARQUE ORLA PIRATININGA: Trecho 4



PARQUE ORLA PIRATININGA: Trecho 4



PARQUE ORLA PIRATININGA: Trecho 5

► BARRA DA LAGOA DE PIRATININGA – RECUPERAÇÃO ECOLÓGICA



PARQUE ORLA PIRATININGA: Trecho 6

- ▶ INÍCIO DA AVENIDA DO FORTE A AVENIDA DOS GOLFINHOS E ILHA DO TIBAU



PARQUE ORLA PIRATININGA: Trecho 6

▶ TIPOLOGIA CICLOVIÁRIA

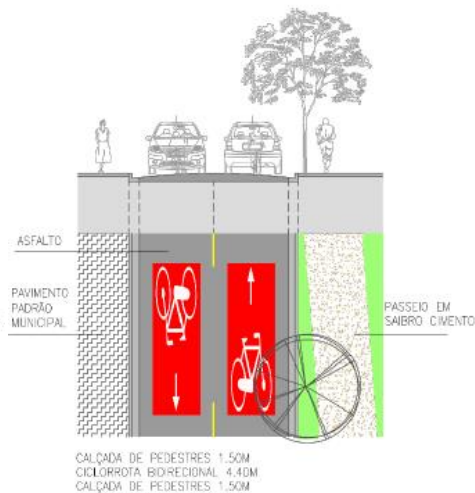
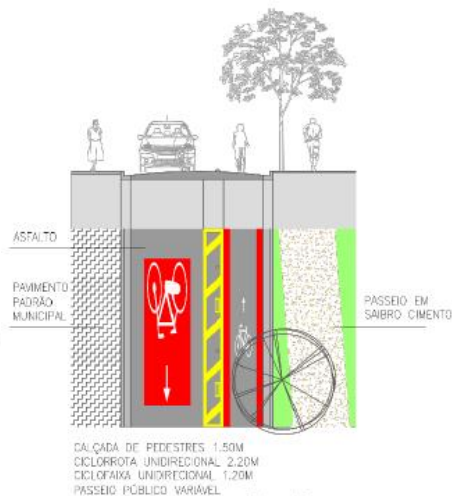
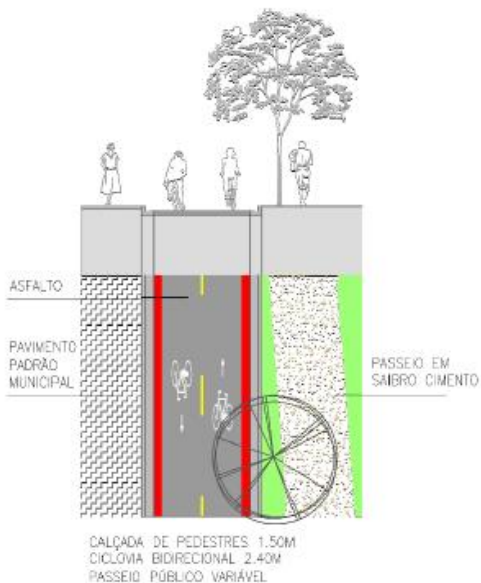

PARQUE ORLA PIRATININGA: Trecho 6



PARQUE ORLA PIRATININGA: Trecho 6

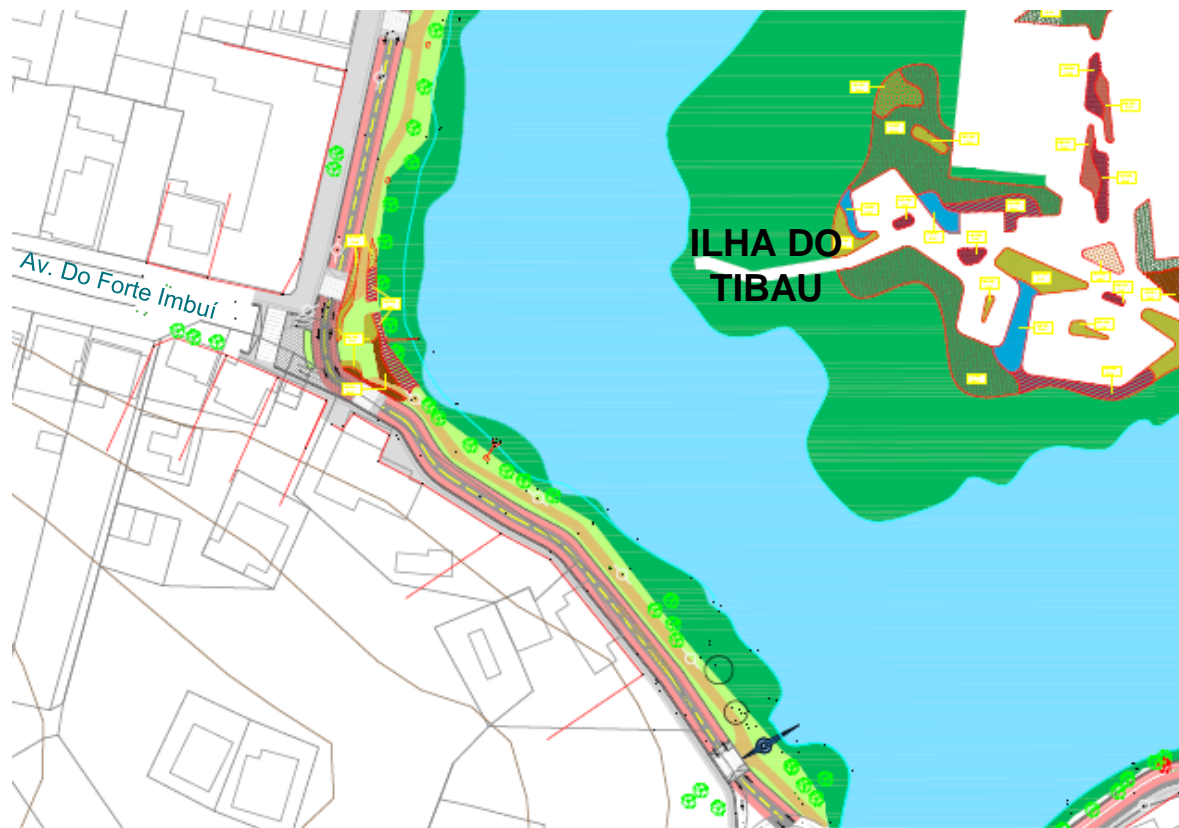

PARQUE ORLA PIRATININGA: Trecho 6

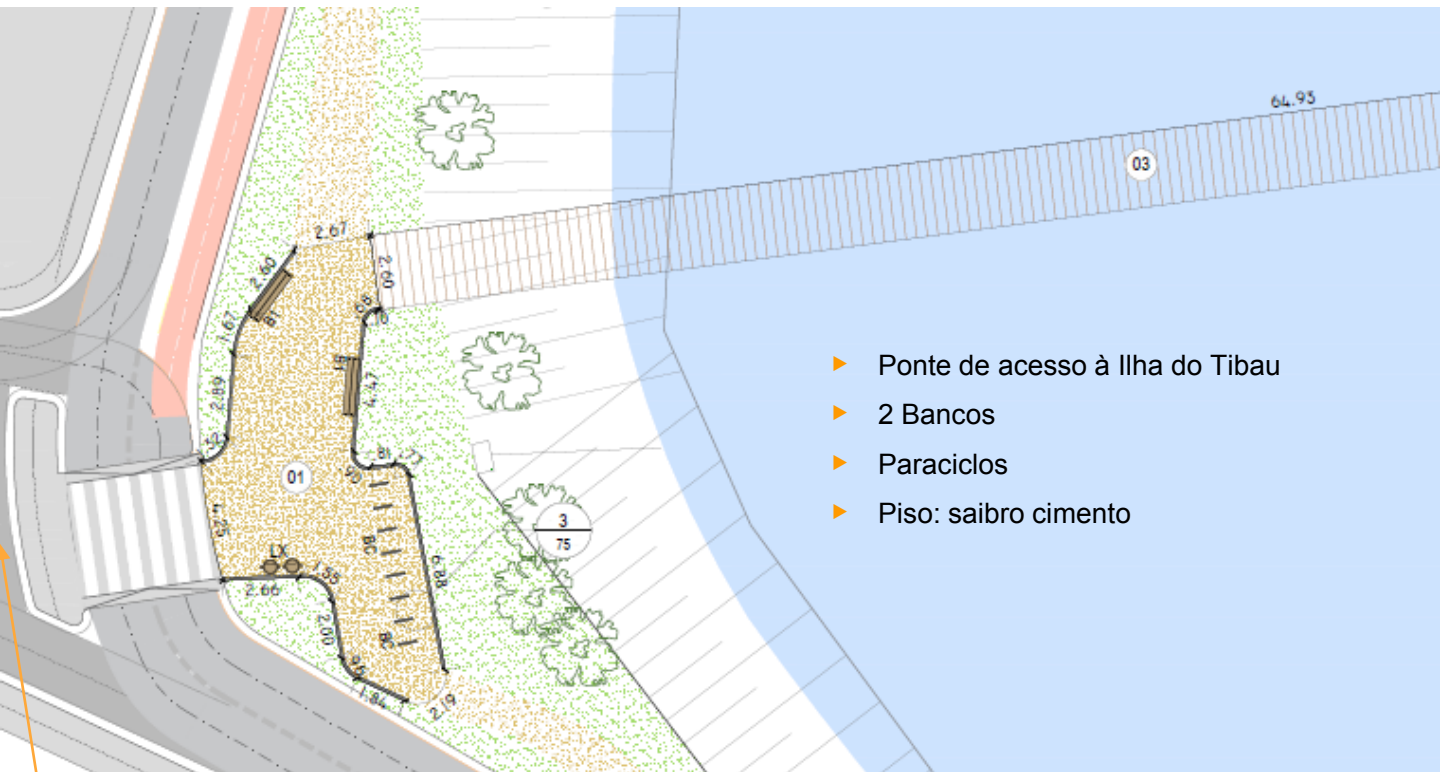

- ▶ Ponte de acesso à Ilha do Tibau
- ▶ 2 Bancos
- ▶ Paraciclos
- ▶ Piso: saibro cimento

Av. do Forte Imbuí

PARQUE ORLA PIRATININGA: Trecho 6

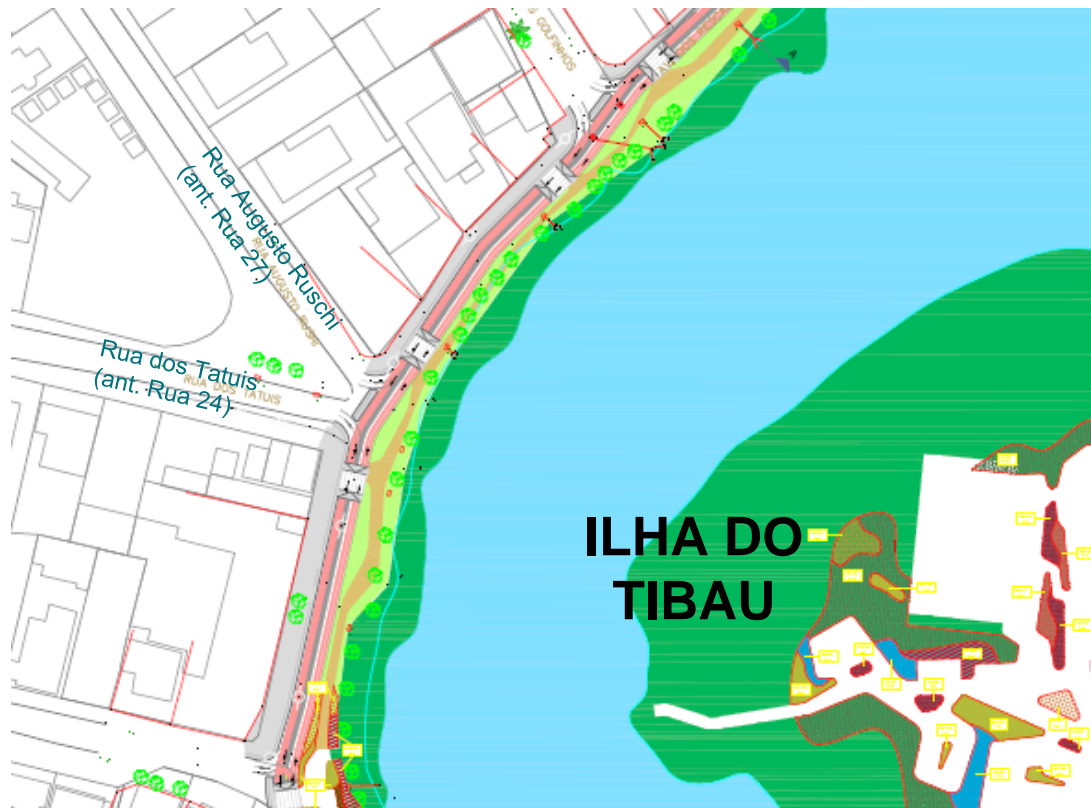

PARQUE ORLA PIRATININGA: Trecho 6

▶ ILHA DO TIBAU

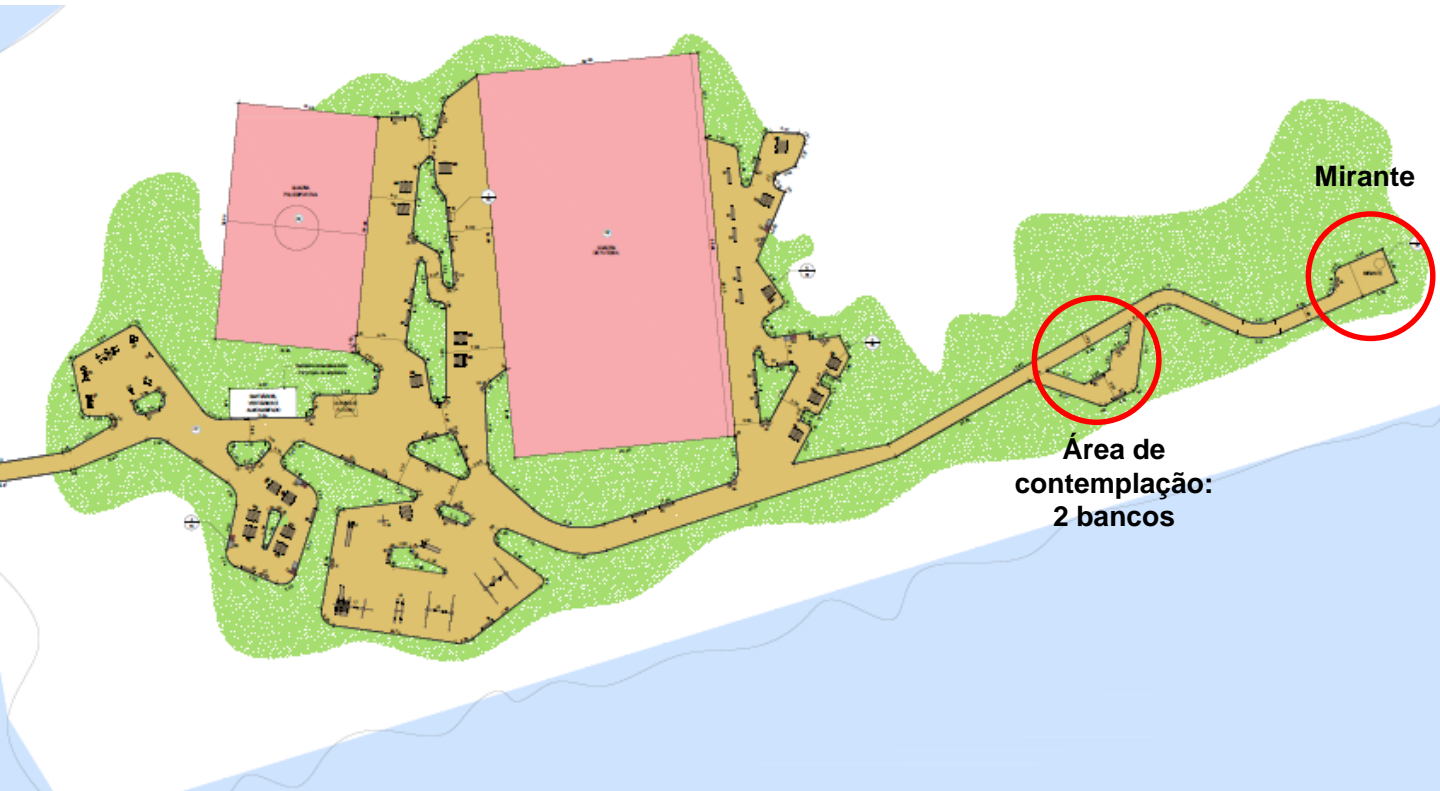

PARQUE ORLA PIRATININGA: Trecho 6

- ▶ 19 mesas
- ▶ 32 Bancos
- ▶ 5 churrasqueiras
- ▶ Quadra poliesportiva (concreto)
- ▶ Quadra de Futebol (saibro)
- ▶ Piso: saibro cimento

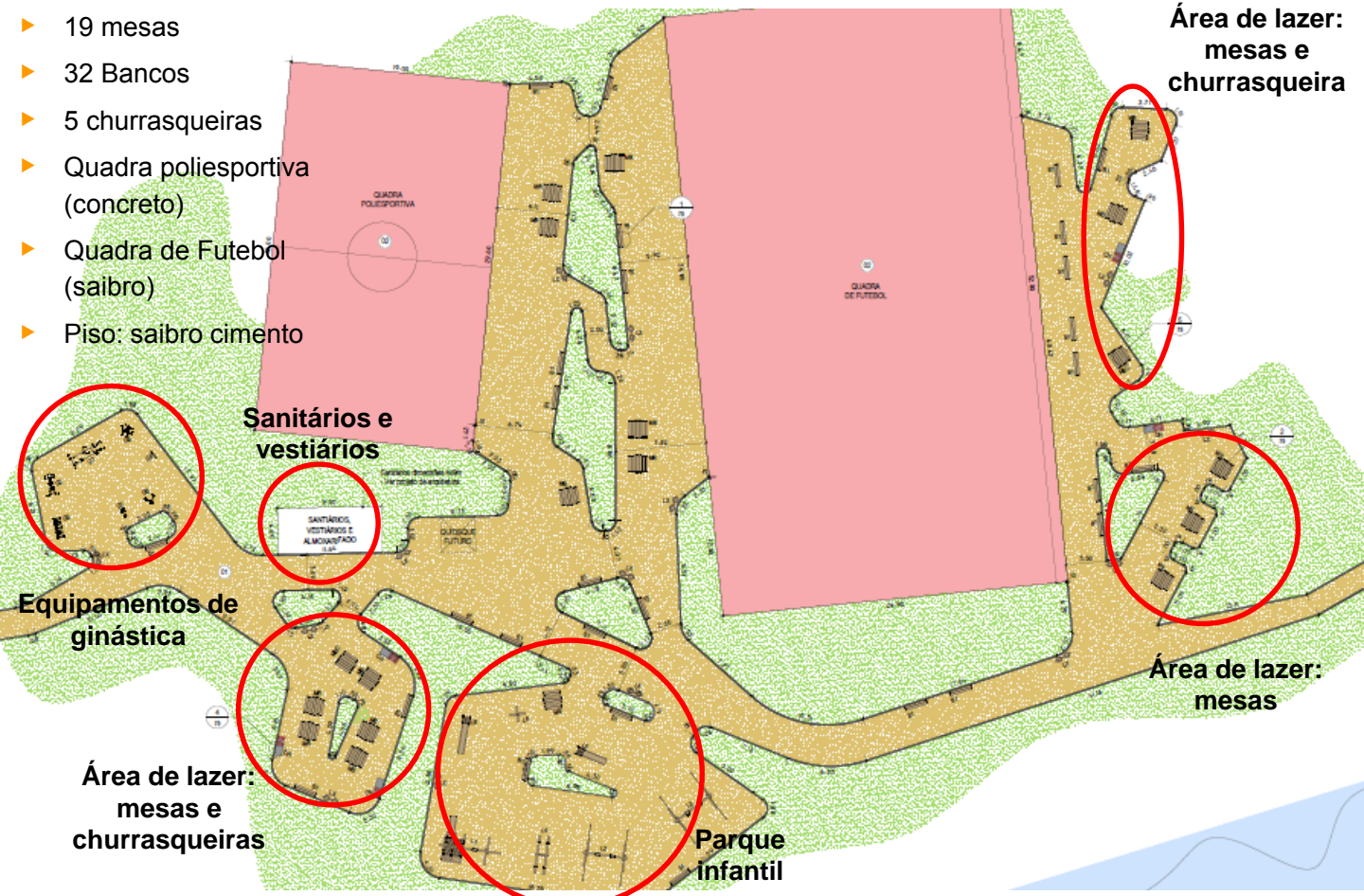

Área de lazer:
mesas e
churrasqueira

Sanitários e
vestiários

SANTUÁRIO,
VESTIÁRIO E
ALMOVARFADO
FUTURO

Equipamentos de
ginástica

Área de lazer:
mesas e
churrasqueiras

Parque
Infantil

Área de lazer:
mesas

PARQUE ORLA PIRATININGA: Trecho 7

- ▶ AV. DOS GOLFINHOS AO FINAL DA AV. DOS PESCADORES



PARQUE ORLA PIRATININGA: Trecho 7



PARQUE ORLA PIRATININGA: Trecho 7



PARQUE ORLA PIRATININGA: Trecho 7

▶ PÍER DE PESCA – FINAL DA RUA DOS PAMPÓS

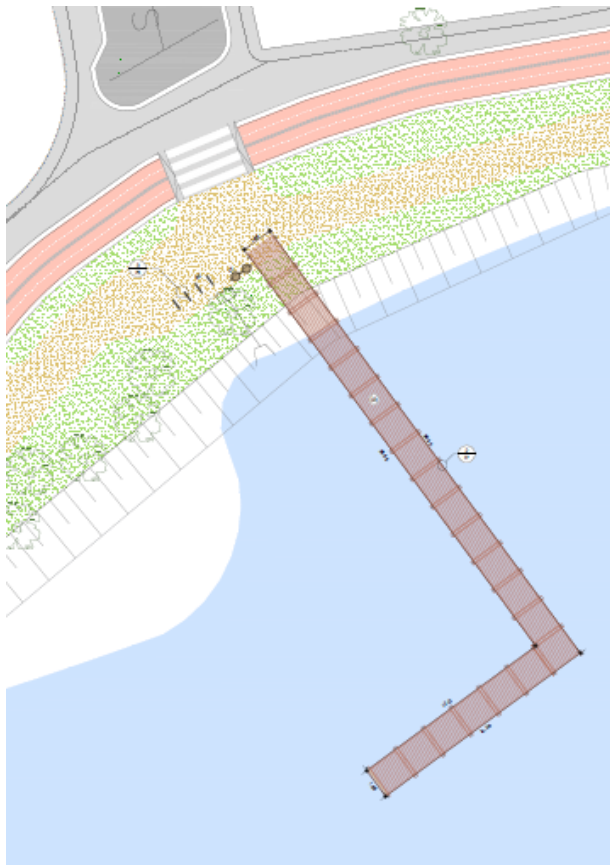

Localização

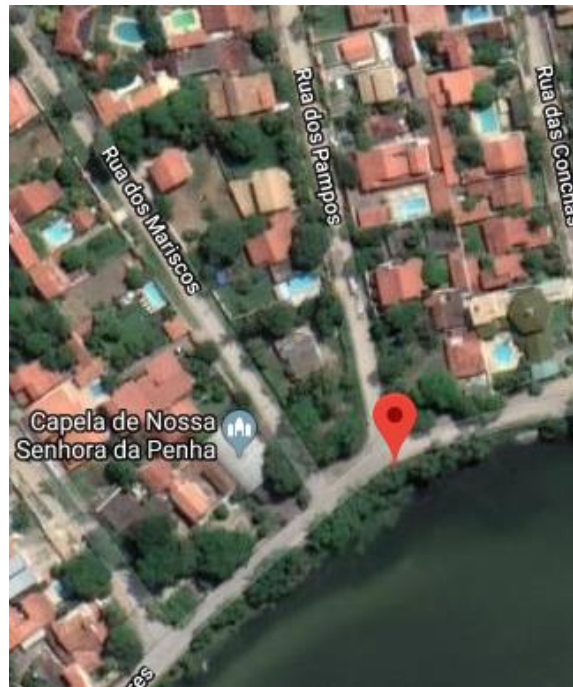

PARQUE ORLA PIRATININGA: Trecho 7



PARQUE ORLA PIRATININGA: Trecho 7



PARQUE ORLA PIRATININGA: Trecho 7



PARQUE ORLA PIRATININGA: Trecho 8

MOBILIÁRIO

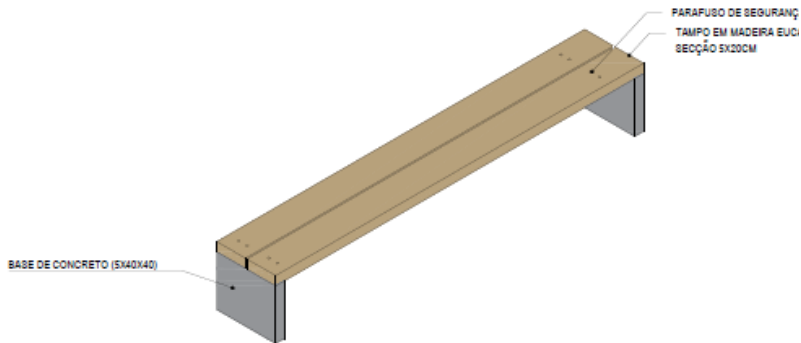

DET. 1 BANCO 1 - ISOMÉTRICA

01 | ESC: 1:25

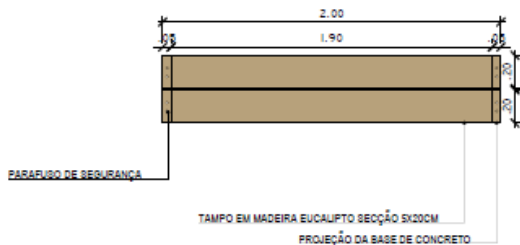

DET. 1 BANCO 1 - PLANTA BAIXA

02 | ESC: 1:25

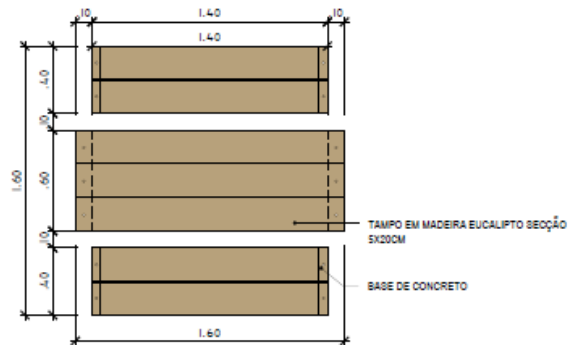

DET. 2 MESA - PLANTA BAIXA

05 | ESC: 1:25

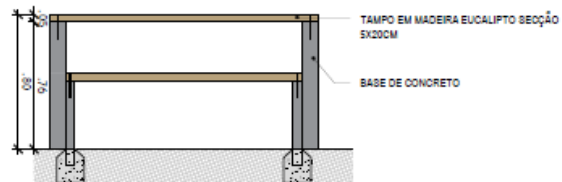

DET. 2 MESA - VISTA FRONTAL

06 | ESC: 1:25

PARQUE ORLA PIRATININGA: Trecho 8

► MOBILIÁRIO

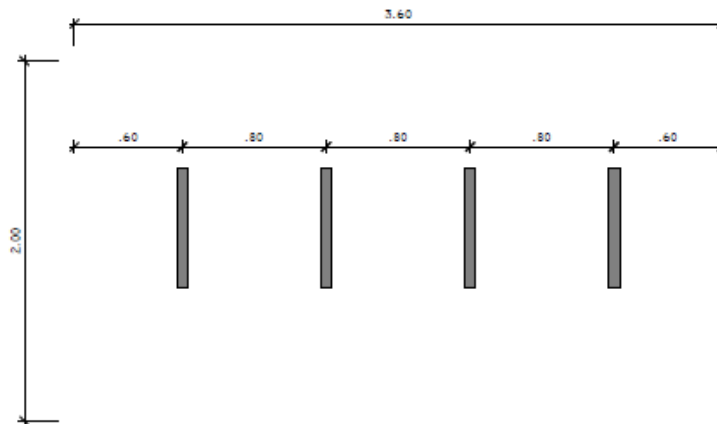

DET. 3 - BICICLETÁRIO

08 | ESC: 1:25

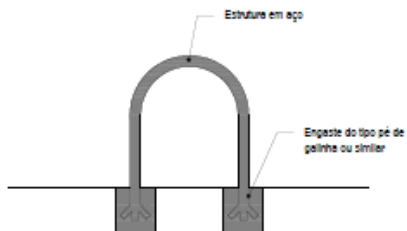

DET. 3 BICICLETÁRIO - VISTA LATERAL

09 | ESC: 1:25

PARQUE ORLA PIRATININGA: Trecho 8

► MOBILIÁRIO

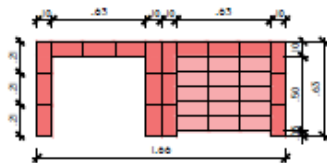

DET. 1 CHURRASQUEIRA - PLANTA BAIXA
01 | ESC: 1:25

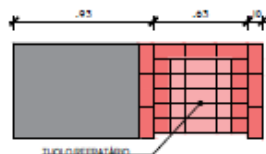

DET. 1 CHURRASQUEIRA - VISTA SUPERIOR
02 | ESC: 1:25

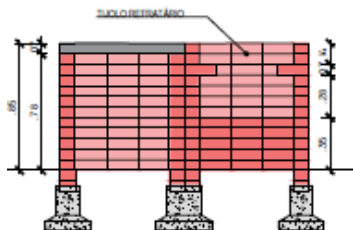

DET. 1 CHURRASQUEIRA - VISTA FRONTAL
03 | ESC: 1:25

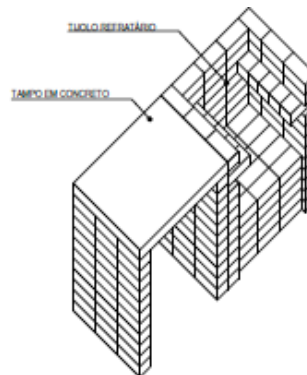

DET. 1 CHURRASQUEIRA - ISOMÉTRICA
04 | ESC: 1:25

PARQUE ORLA PIRATININGA: Trecho 8

PIER

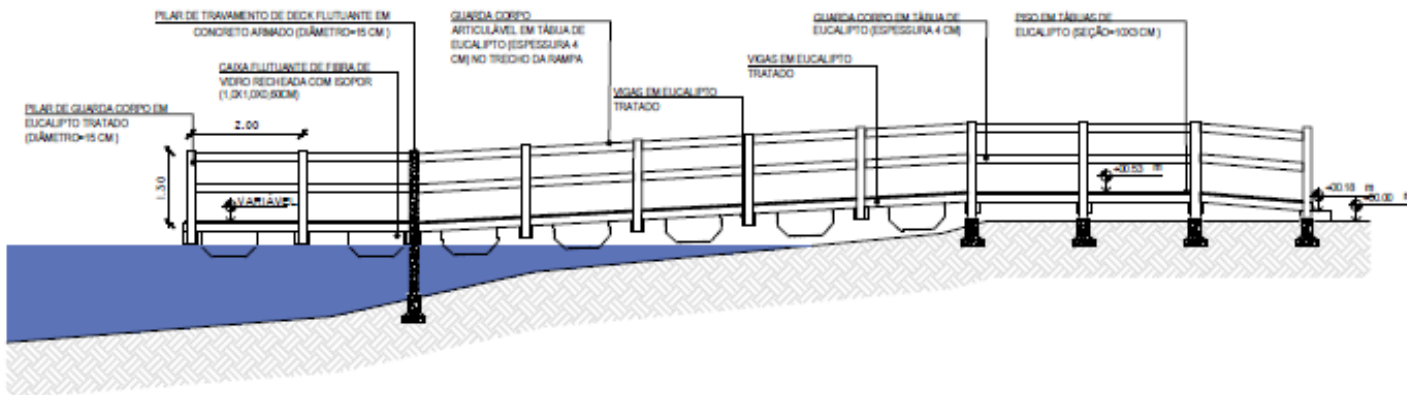

PARQUE ORLA PIRATININGA: Trecho 8

► MIRANTE

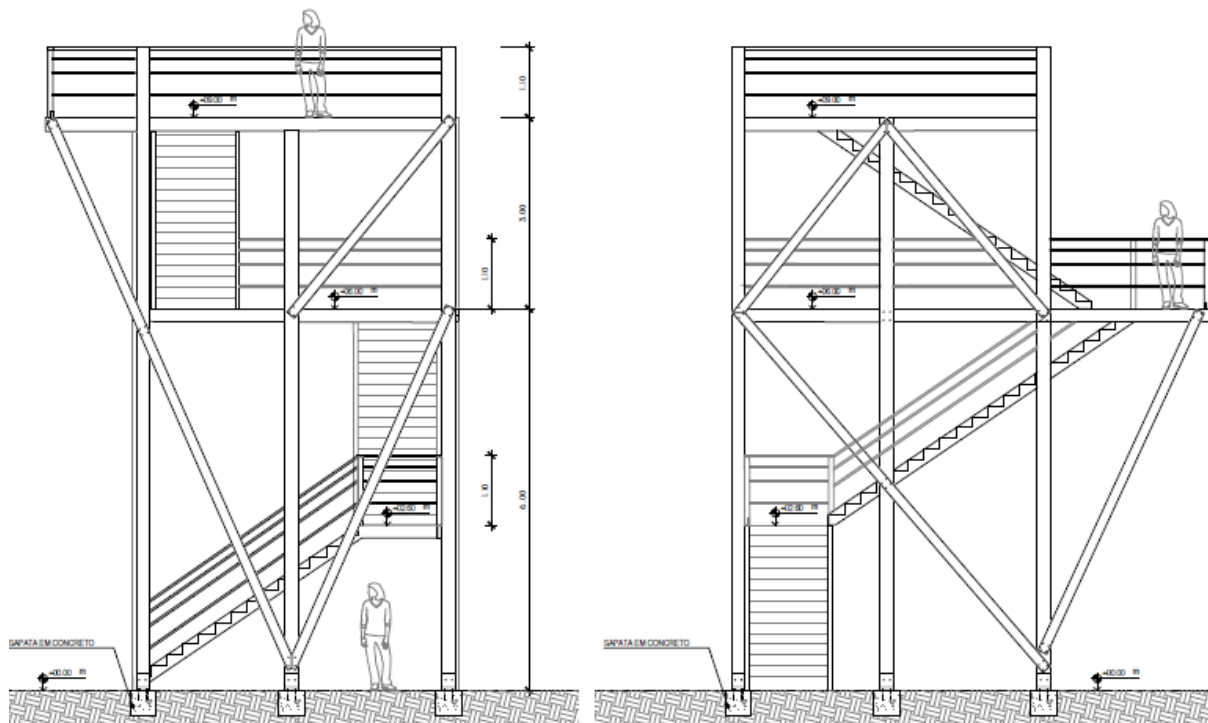



INFRAESTRUTURA VERDE

INFRAESTRUTURA VERDE

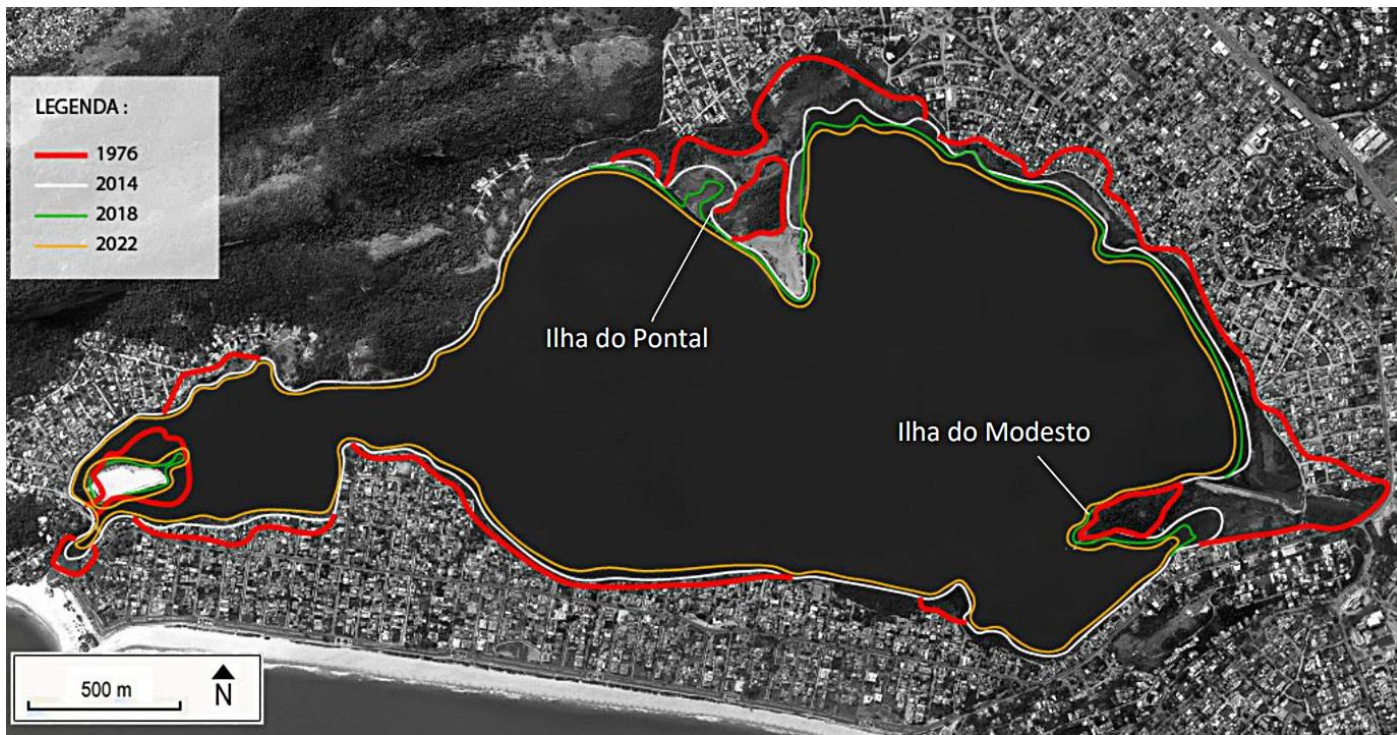

Fonte: Elaborado por Phytorestore baseado em estudo realizado por FONTENELLE T.H. e CÔRREA W.B. – Universidade Federal Fluminense Rio de Janeiro
“Impacto da urbanização no espelho d’água do sistema lagunar de Itaipu e de Piratininga Niterói (RJ), Maio – Agosto 2014; Foto de satélite utilizada do Google Earth.

INFRAESTRUTURA VERDE: Alagados construídos

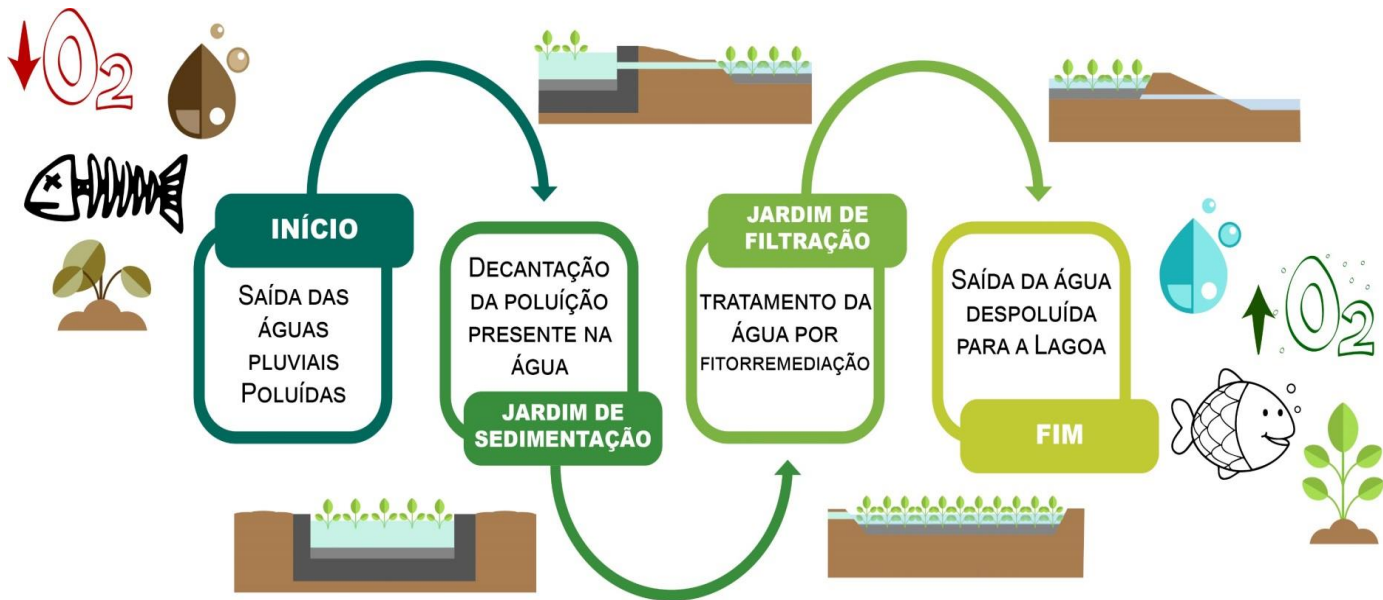

INFRAESTRUTURA VERDE: Alagados construídos

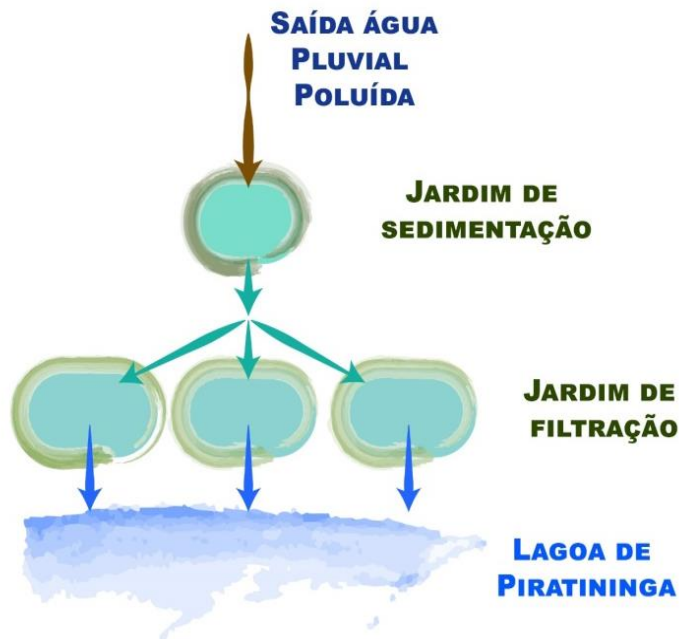

INFRAESTRUTURA VERDE: Alagados construídos

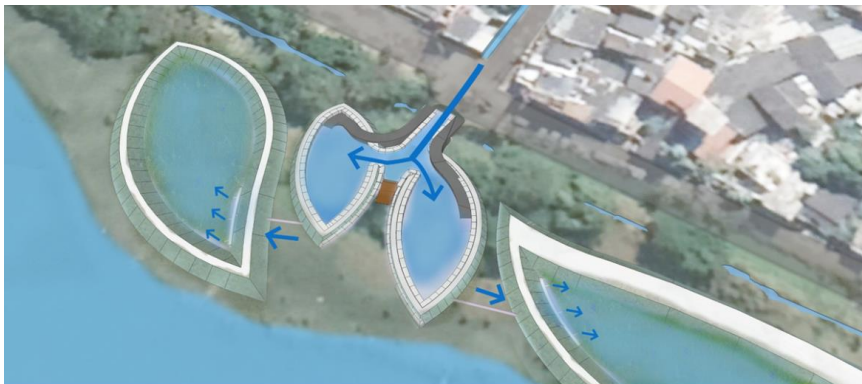

Funcionamento do sistema de alagados construídos durante o período sem chuvas

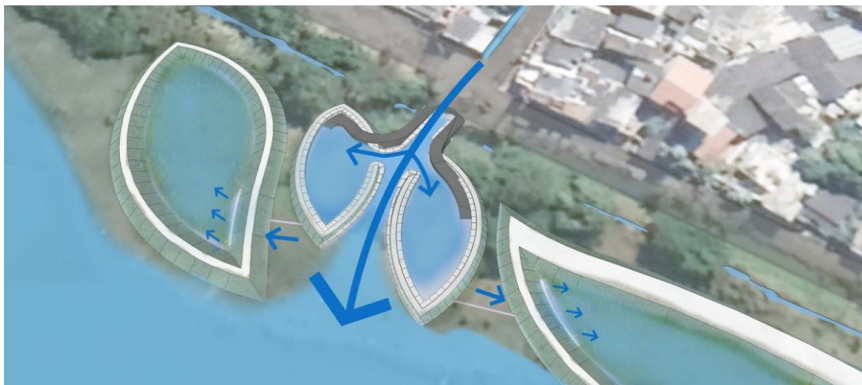

Funcionamento do sistema de alagados construídos durante o período chuvoso



AMOSTRAS DE ÁGUAS
PLUVIAIS

INFRAESTRUTURA VERDE: Alagados construídos

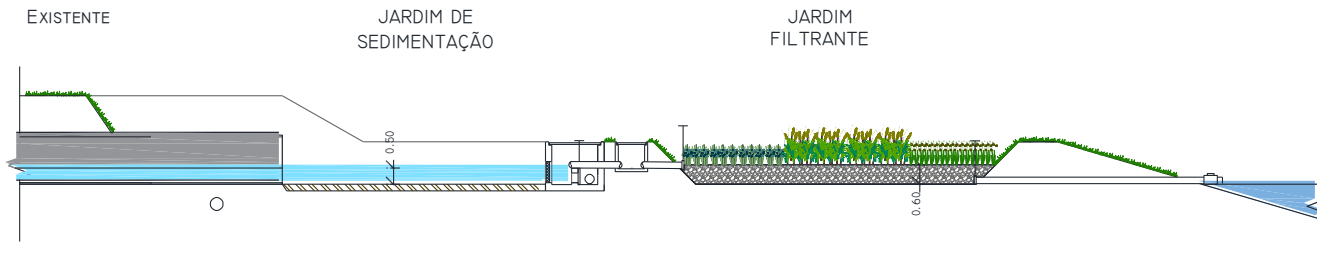
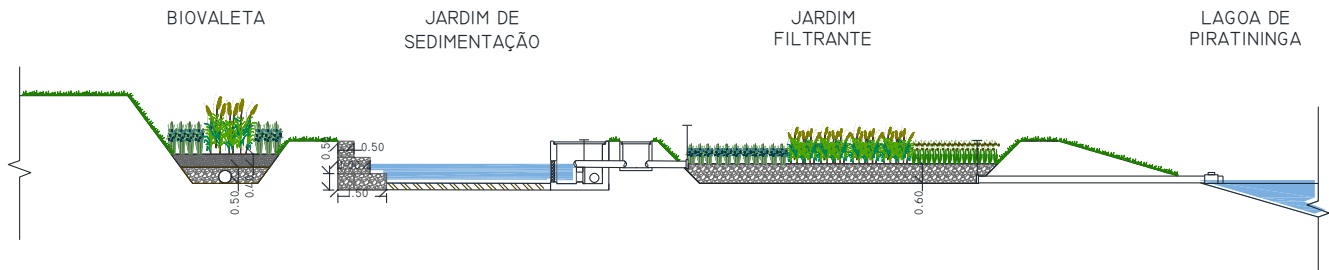

INFRAESTRUTURA VERDE: Alagados construídos

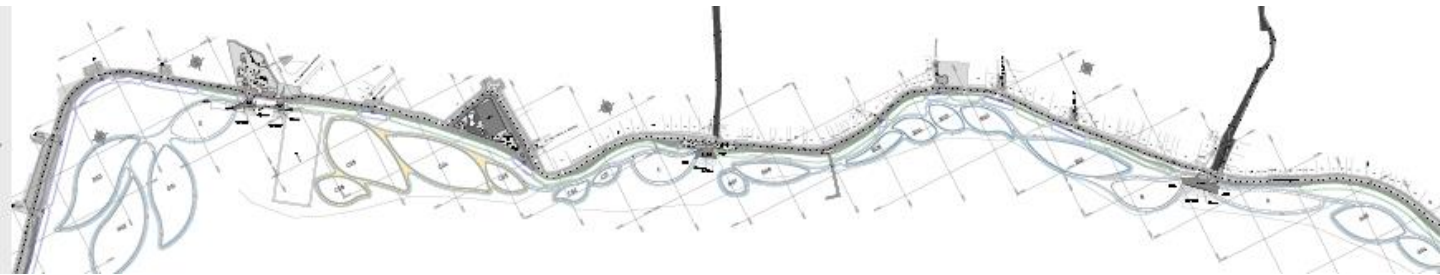

TRECHOS 9 e 1

INFRAESTRUTURA VERDE: Alagados construídos

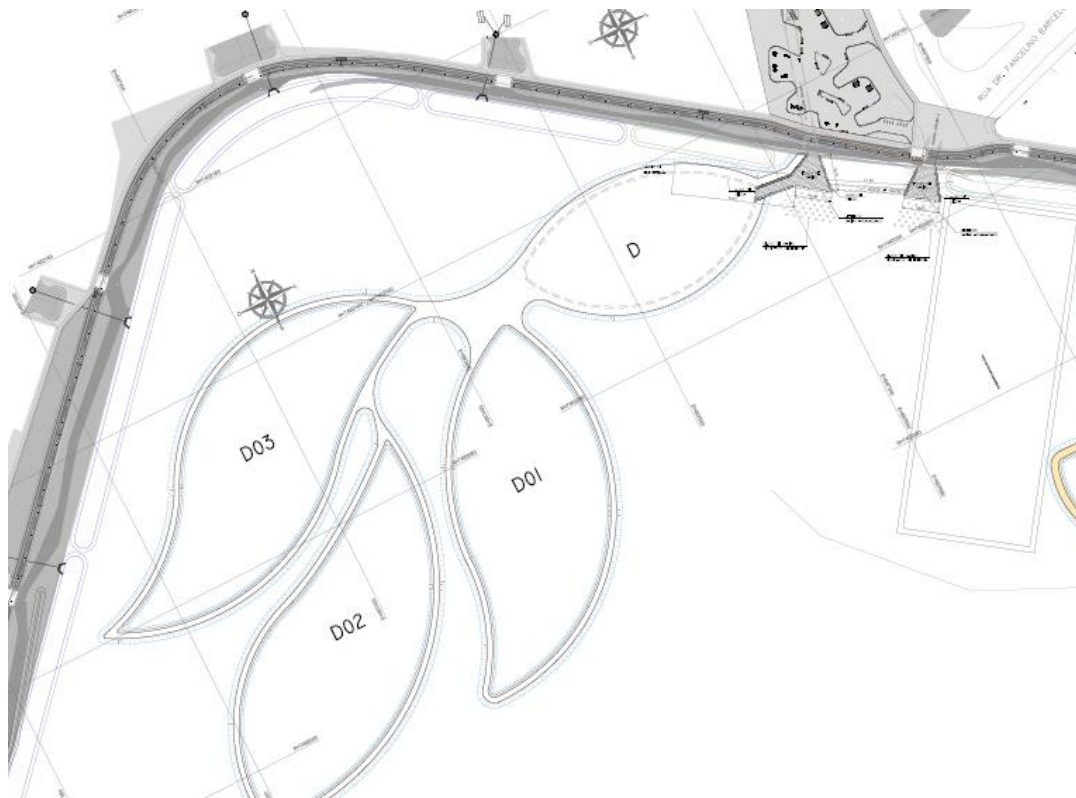

INFRAESTRUTURA VERDE: Alagados construídos

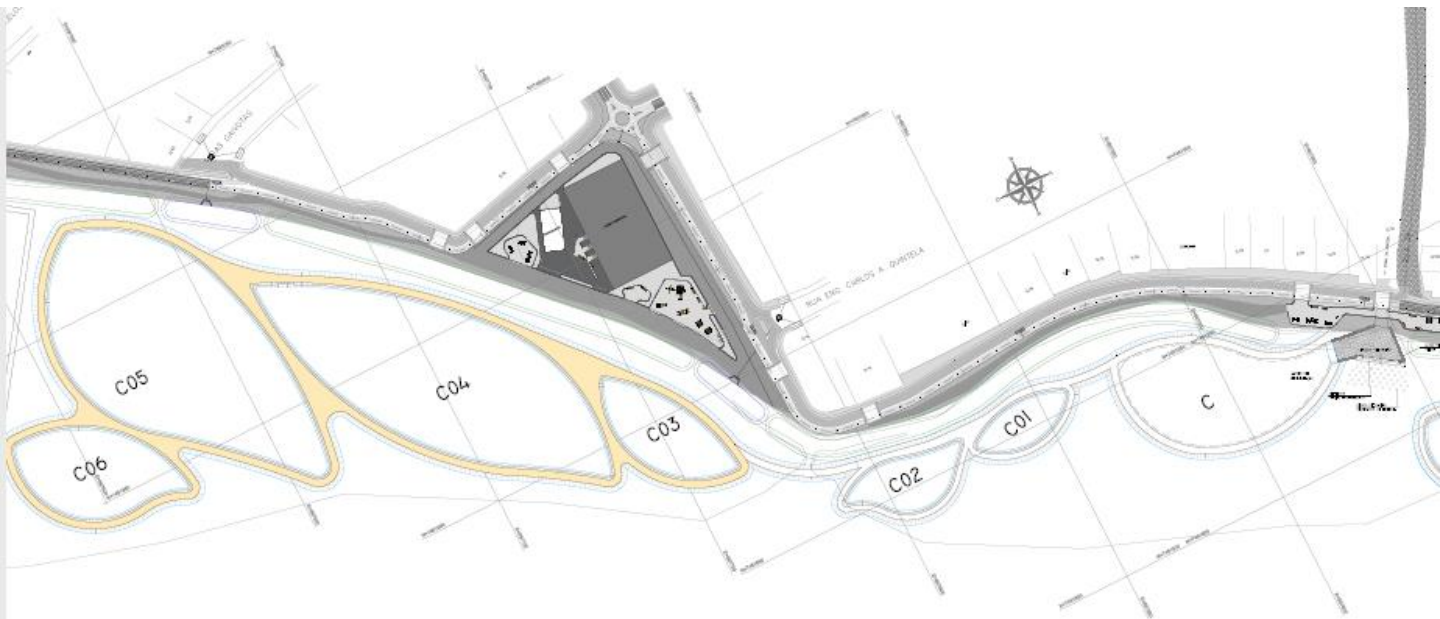

INFRAESTRUTURA VERDE: Alagados construídos

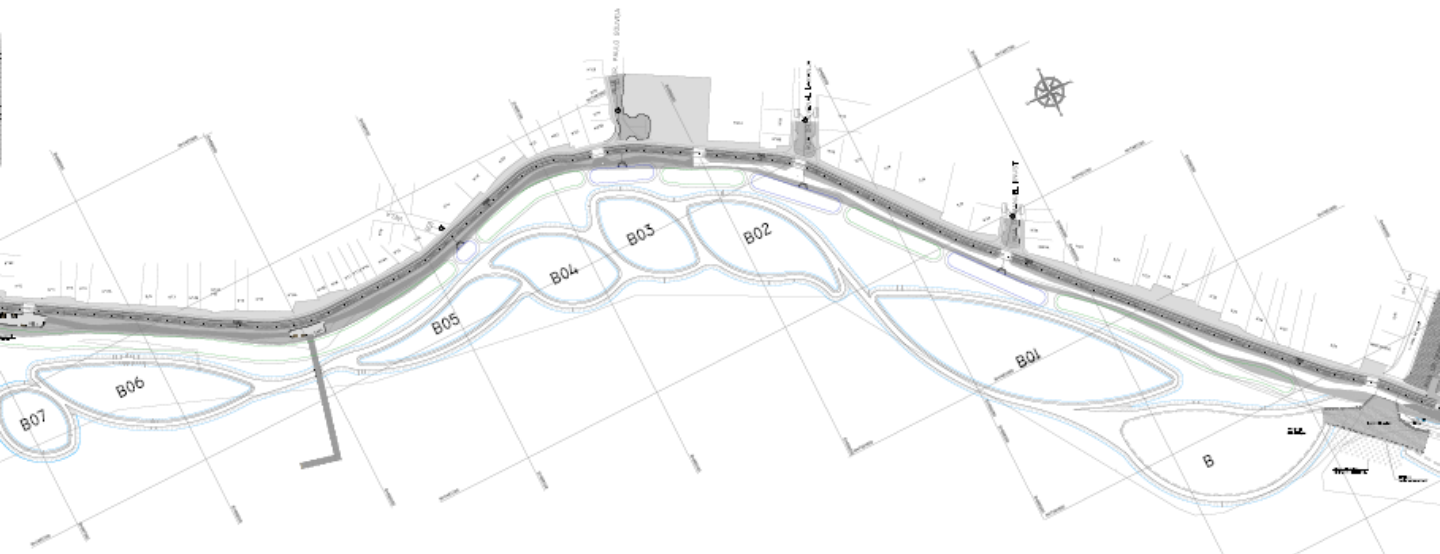

INFRAESTRUTURA VERDE: Alagados construídos

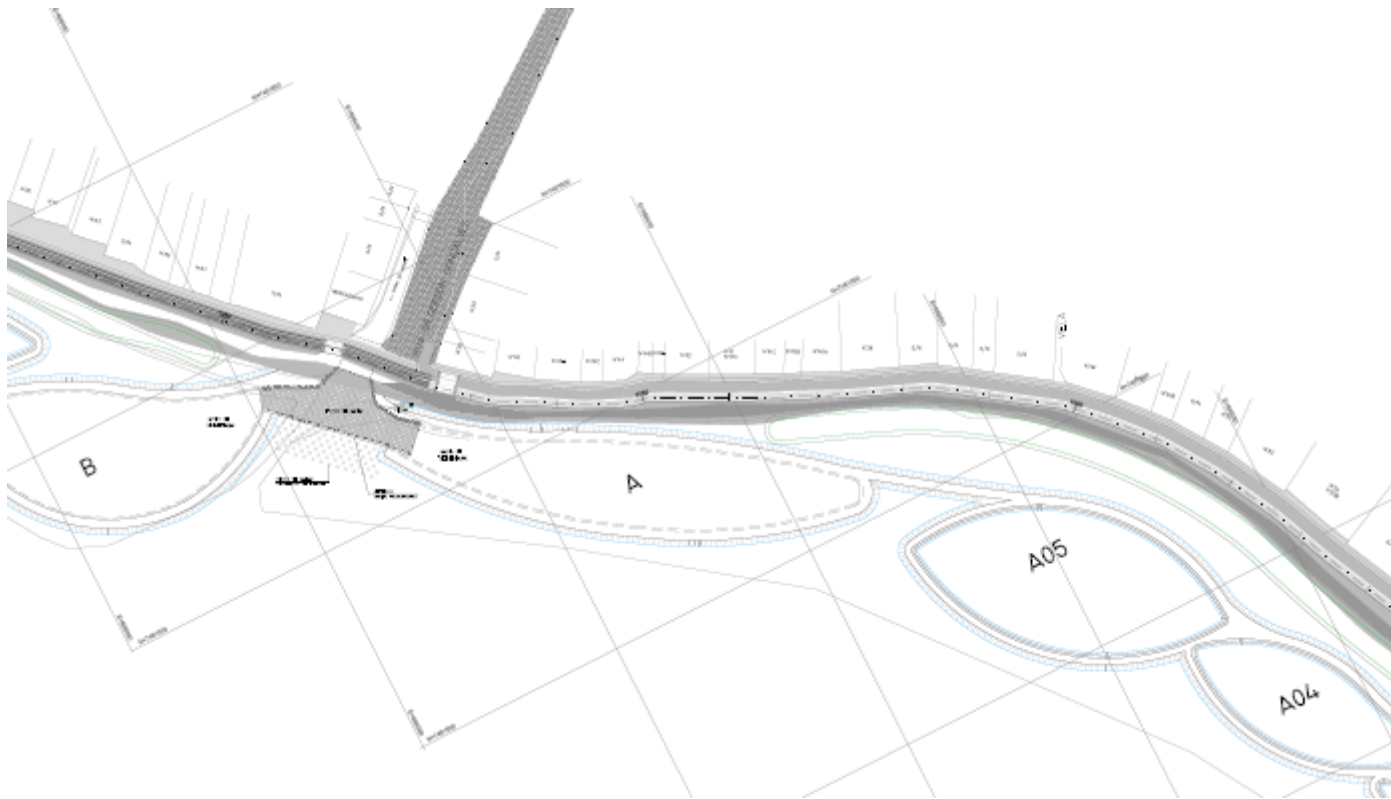

INFRAESTRUTURA VERDE: Alagados construídos



SITUAÇÃO ATUAL

SITUAÇÃO ESPERADA (Referência)



INFRAESTRUTURA VERDE: Alagados construídos



JARDINS
FILTRANTES

RECOMPOSIÇÃO
VEGETAL

JARDIM DE CHUVA
(Canal de cintura
reformulado)

INFRAESTRUTURA VERDE: Alagados construídos

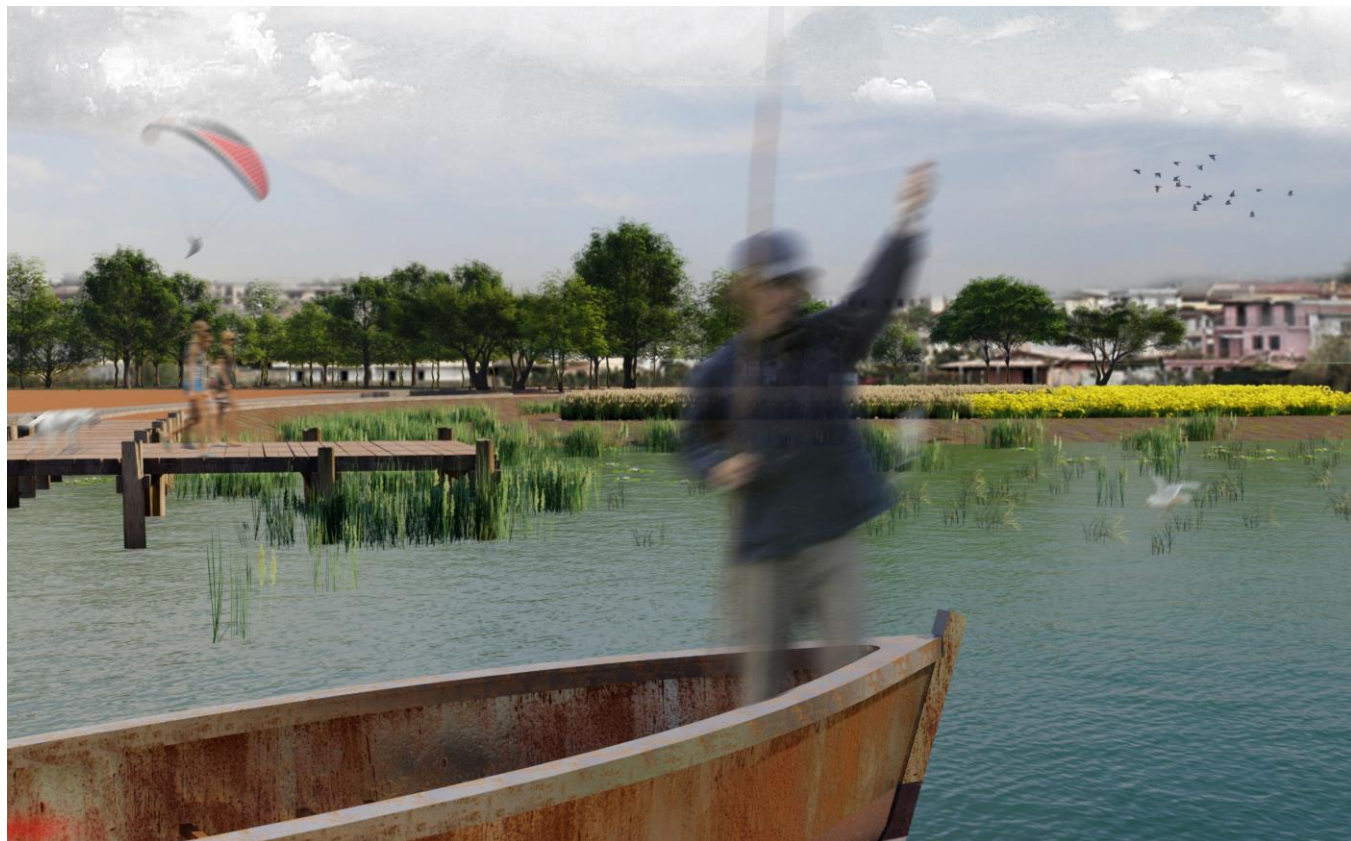

INFRAESTRUTURA VERDE: Jardins de chuva

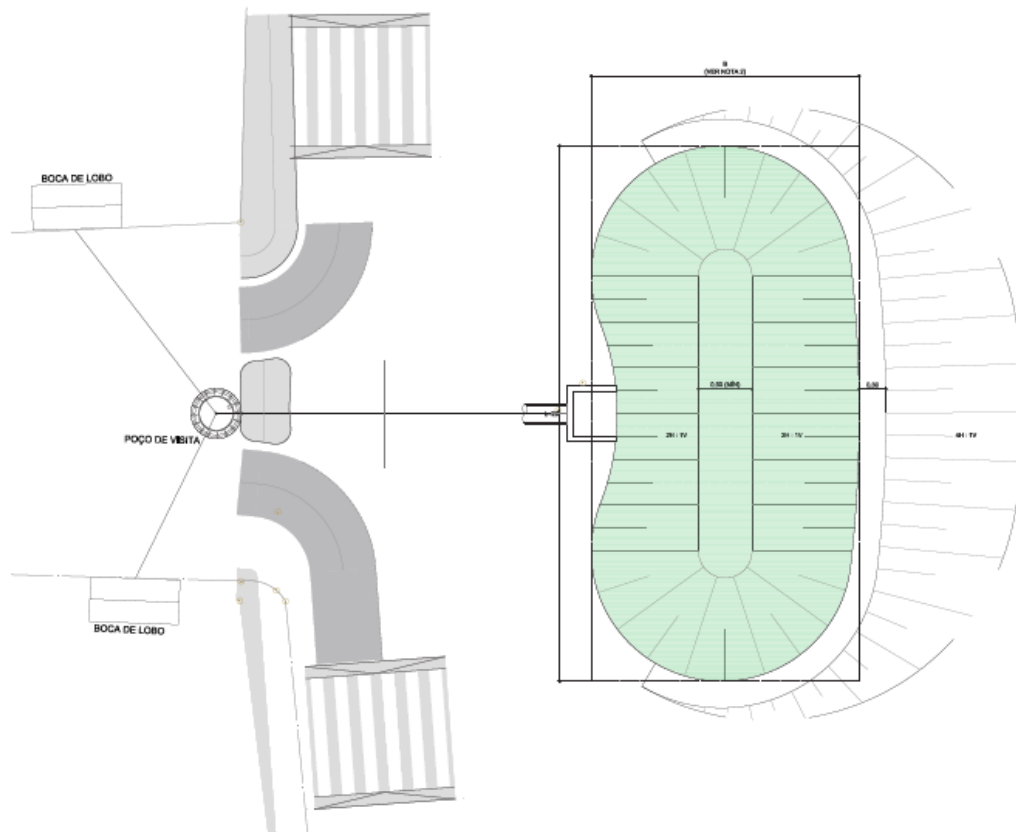

INFRAESTRUTURA VERDE: Jardins de chuva

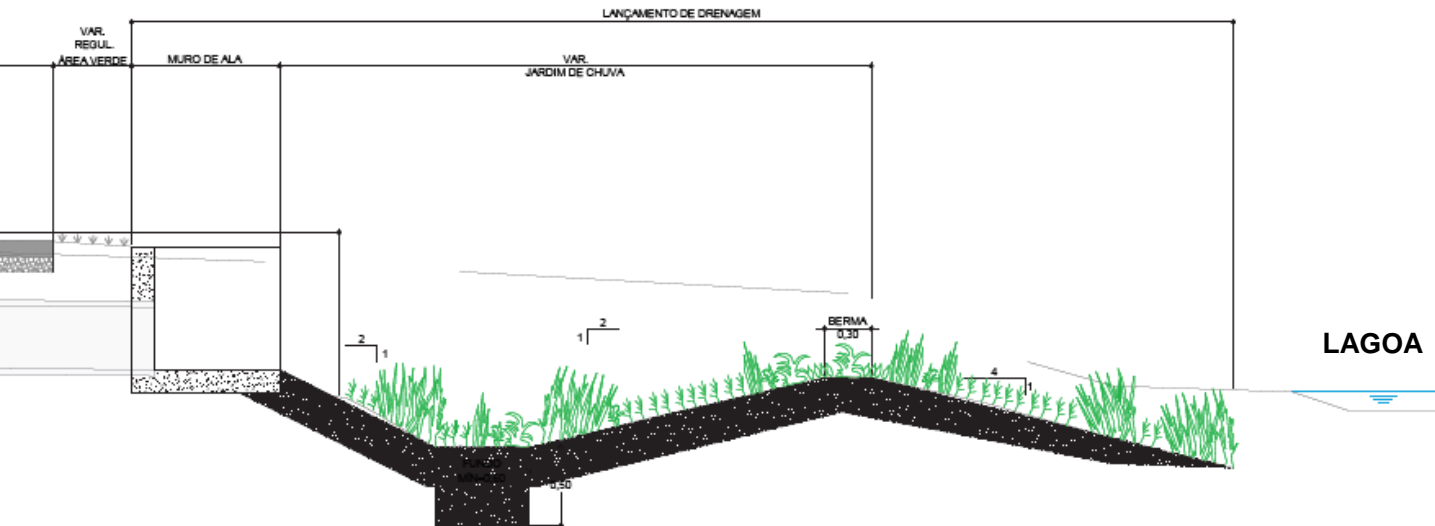



www.prosustentavel.niteroi.rj.gov.br

ugpcaf.niteroi@gmail.com

Tel: 2620-6609